

Flush-mounted radio with display RAD...



Device description

The Jung flush-mounted radio RAD... consists of a display cover and a flush-mounted power supply unit.

The display cover is used for display and operation. All the settings are made using the 8 sensor buttons. The display shows the station information from RDS, the time and the current settings.

The radio power supply unit contains the connections for the mains voltage, inputs and the loudspeaker.

The radio can be operated with one or two LSM... loudspeaker modules.

The extension input allows the radio to be switched on or off, e.g. together with the light.

The radio signal is obtained from the connection to the mains voltage. In situations where reception is difficult, the optional cord aerial can be used.

Other audio sources can be played back using an AUX input, e.g. using the music centre MC..100... .

Safety information

Electrical equipment must only be installed and assembled by qualified electricians.

Failure to comply with these instructions may result in damage to the device, fire or other hazards.

This product is only intended for use in dry rooms.

These instructions are a component part of the product and must remain with the end customer.

Operation

The lower half of the cover is used for operation. All operation is carried out using 8 sensor buttons.

When idle, the buttons and display may be hidden, depending on the settings. They are reactivated when the sensor buttons are touched again.



Switch-on / Switch-off

 The radio is switched on and off here.

If the button is pressed for 3 seconds when the system is switched on, then the sleep timer (fall asleep function) can be activated.

Settings

 Basic configuration of brightnesses, alarm time, and much more.

Alarm functions

 The alarm, which has a gradually increasing volume, is switched on and off here.

If the button is pressed for longer than 3 seconds, this opens the menu for setting the alarm time.

Favourites

 Preferred stations can be saved to the Favourites or the AUX input selected.

Operating buttons

Station search, volume setting and the  navigation/setting in the menu.

Brightness of display during standby

 adjusts the brightness for the standby state. The lowest level is Night mode.

Night mode

In Night mode, the display is switched off completely as standby.

Pressing any button brings the display back from Night mode.

Main menu



After switch-on, the station information and status line are shown in the display.



The status line provides information on the selected favourites, time and alarm operation.

When idle, this information is reduced to the time and date.

Station selection

The next station is selected using the  buttons.

RDS (Radio Data System)

During operation, the display shows the station name and, in some cases, additional information, e.g. on the current song. If this information is not available, then frequency information on the selected radio station is displayed.

Adjusting the volume

The volume is adjusted using .

Favourites

Briefly pressing the  button selects the saved favourites or the AUX input.



Cancel Select +/- Confirm

In radio operation, a long press of the  button (> 3 s) adds the current station to the Favourites list. Up to 8 favourites are possible.

Settings

The submenus can be found using the  button. The menu is operated with the sensor buttons below.



Cancel Select +/- Confirm

Here you can select one of the following 8 submenus with the +/- buttons.

With the button  you get into the selected submenu to change required settings.

AUX input



When the AUX input is activated, radio reception is terminated and playback comes from the external source. If the input is deactivated again, radio operation will recommence.

Alarm time



The set alarm time starts the radio with an increasing volume.

The display and buttons are previously illuminated at full brightness.

The  buttons terminate any further increase in volume.

The  button switches the alarm off.

The  button switches the function on and off.

Sleeptimer (Fall asleep function)



The Sleeptimer (fall asleep function) switches the radio off automatically after the selected period of time. The countdown is displayed in the status line.

Button brightness



The brightness and switch-off behaviour of the buttons can be varied. On switching-off, the information in the display is reduced to the display of station name and the time.

If the system is operated again, the buttons become brighter again.

Brightness of operational display

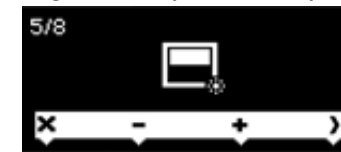

The display brightness can be reduced.

Loudspeaker



During operation, the radio switches between stereo and mono operation automatically. If reception conditions are variable, it may be wise to select continuous mono operation. This allows two different areas to be filled with sound.

Time



Normally, the reception of an RDS station is sufficient to perform this setting automatically. However, the current time can also be set manually.

Default setting



The state as delivered is restored. In so doing, the 8 strongest stations are saved automatically.

Flush-mounted radio with display RAD...

Operating instructions

Albrecht Jung GmbH & Co. KG

Volmestrasse 1
58579 Schalksmühle
Germany

www.jung.de

We reserve the right to make technical changes.
en_RAD_V3.docx
02/2014
0024073100



The CE symbol is a free trade symbol, intended solely for the authorities and does not carry any guarantee of properties.

Guarantee

Our products are under guarantee within the scope of the statutory provisions. Please send the device, postage paid, to our central Customer Service Centre, with a description of the error.

ALBRECHT JUNG GMBH & CO. KG

Volmestrasse 1
58579 Schalksmühle
Germany

Telephone: +49 2355 806-0
Fax: +49 2355 806-204
kundencenter@jung.de
www.jung.de

Service Centre

Kupferstr. 17-19
44532 Lünen
Germany

Correct use

- Installation in a flush-mounted device box according to DIN EN 49073 (Recommendation: Deep sockets)
- VHF reception in the frequency range 87.5 MHz to 108 MHz

Product properties

- VHF radio with display and sensor buttons
- Real glass front panel
- Stereo reception
- Connection terminals for two loudspeakers
- Stereo/mono switch-over
- Simple operation
- Integrated VHF aerial
- High level of reception quality
- Automatic and manual station search
- Storage of 8 favourites
- Switch-on with most recent station
- Switch-on with most recent volume
- Alarm function
- Sleep mode
- Switch-on/switch-off using extension
- Optional external cord aerial
Art. no. RAD-ANT available as accessory

Mounting

The radio RAD... is designed for mounting in flush-mounted DIN EN 49073 sockets.

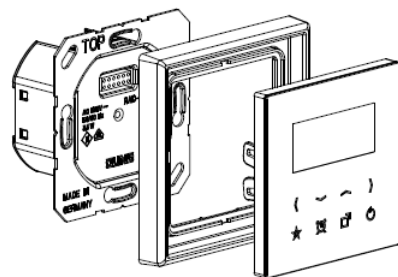

The flush-mounted power supply unit contains the connections for the mains voltage, loudspeaker and possibly the extension.

The display cover is attached to the power supply unit together with the frame.



DANGER!

Touching live parts can result in an electric shock.
An electric shock can be fatal.
Before working, disconnect all the appropriate cable protection switches. Cover live parts in the vicinity.

Mains connection

The radio requires a permanent mains power connection.

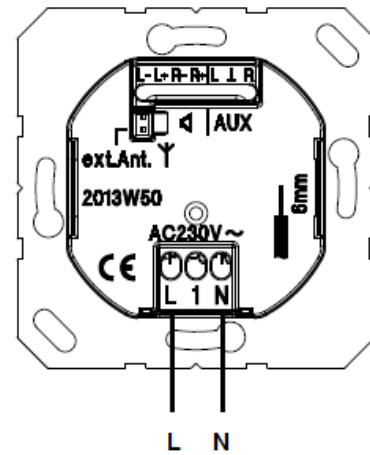

It is not allowed to use the terminals to loop through wires.

Connecting the extension

The extension connection is used to switch the radio off and on using switches, e.g. together with the light.

The extension input may only be operated with the same phase as the radio.

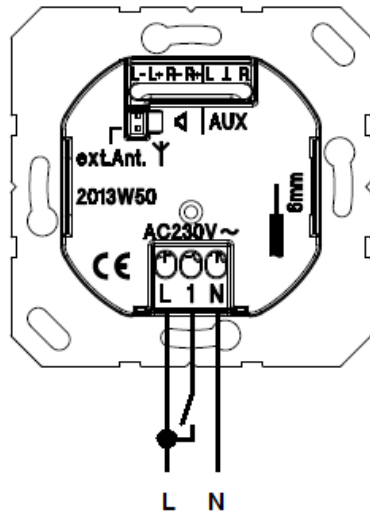

Connecting an external cord aerial

The rear-side connection for the external aerial may only be used to connect the cord aerial, art. no. RAD-ANT. Connection to roof aerials of shared aerial systems is not permitted.

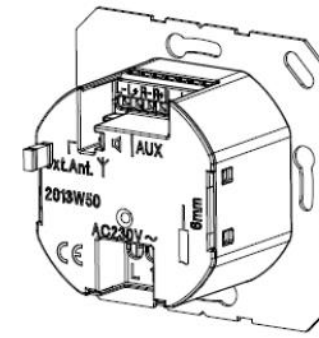

To connect the cord aerial, remove the jumper. Make sure to store the jumper for later use of the radio without cord aerial.

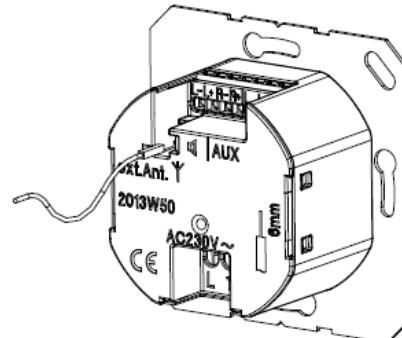

Insert the aerial in the lower connection.

Using the AUX input

The AUX input is used to connect external sources, e.g. the music centre MC..100...

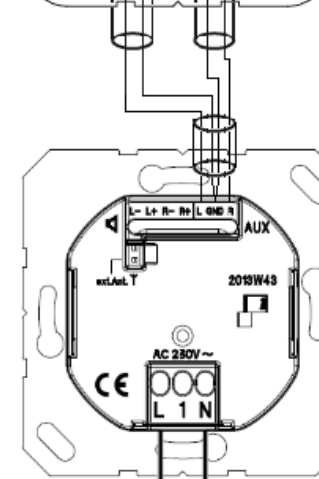
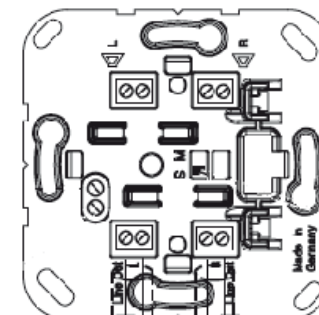

Within the device box, all the cables carrying low voltages (including the optional cord aerial) must have an insulating hose, in

order to guarantee secure isolation. The AUX input is selected using the Favourites button or in the menu.

Connecting a loudspeaker

The radio is designed for operation with one or two LSM... loudspeaker modules. The connection cable can be up to 5 m long.

Within the device box, all the cables carrying low voltages must have an insulating hose, in order to guarantee secure isolation.

In normal stereo operation, both outputs (L+R) are used. If necessary, the receiver switches to mono operation automatically.

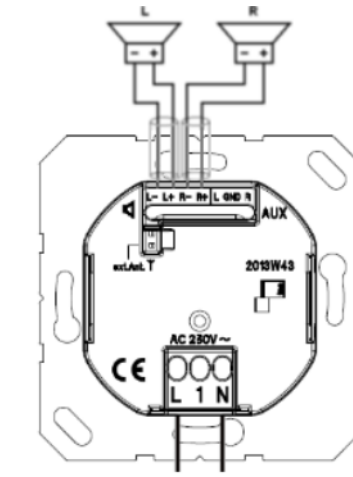

In the case of manual switch-over to mono operation (2 x mono), the radio can also be used with just one loudspeaker.

The connection of multiple loudspeakers to each output is not permitted.

Third-party loudspeakers may only be used if their technical data is identical to the Jung LSM... .

Please observe the polarity.

Mounting of the power supply unit

After connection of all the cables, mount the power supply unit in the device box in the right position.

Mounting of the display unit

After the power supply unit has been mounted in the device box, attach the display cover, including the frame, to the power supply unit in the right position.

First commissioning

Switch the device on using the  button.

During first commissioning, the 8 strongest stations are saved automatically.

If necessary, adjust the settings for the loudspeakers and brightnesses.

Normally the brief reception of an RDS station is sufficient to set the time and date automatically. Otherwise, the time can also be set manually.

Technical data

Radio RAD...

Rated voltage:	AC 230 V ~
Frequency:	50/60 Hz
Ambient temperature:	0 ... + 50 °C
Humidity:	15 % ... 90 %
	No dew formation
Frequency range:	87.50 MHz ... 108.00 MHz
Protection rating:	IP 20
Connection:	Screw terminals
	1 x 2.5 mm ² or 1 x 1.5 mm ²

Loudspeaker connection cable:

Twin-core cable	H03VH-H, 2 x 0.75
	alternatively:
	JY-(St)- Y 2x2x0.6 mm
Length: max:	5 m

Loudspeaker LSM...

Rated power:	2.5 W
Impedance:	4 Ω
Frequency range:	120 ... 15000 Hz (-10 dB)

AUX input:

Impedance:	470 Ω
Input level:	1 V