

Radio universal dimmer, flush-mounted
Art.-No.: FUD 1521 UP

Operating instructions

1 Safety instructions

Electrical equipment may only be installed and fitted by electrically skilled persons.

Failure to observe the instructions may cause damage to the device and result in fire and other hazards.

Danger of electric shock. Always disconnect before carrying out work on the device or load. At the same time, take into account all circuit breakers that supply dangerous voltage to the device or load.

Danger of electric shock. Device is not suitable for disconnection from supply voltage. The load is not electrically isolated from the mains even when the device is switched off.

Do not connect any electronic lamps, e.g. switchable or dimmable compact fluorescent lamps or LED lamps. Device can be damaged.

Fire hazard. For operation with inductive transformers, each transformer must be fused on the primary side in accordance with the manufacturer's instructions. Only safety transformers according to EN 61558-2-6 may be used.

The radio communication takes place via a non-exclusively available transmission path, and is therefore not suitable for safety-related applications, such as emergency stop and emergency call.

Danger of electric shock. The antenna has basic insulation. Do not lead it through the appliance box.

Do not shorten, extend or strip the antenna. Device can be damaged.

These instructions are an integral part of the product, and must remain with the end customer.

2 Device components

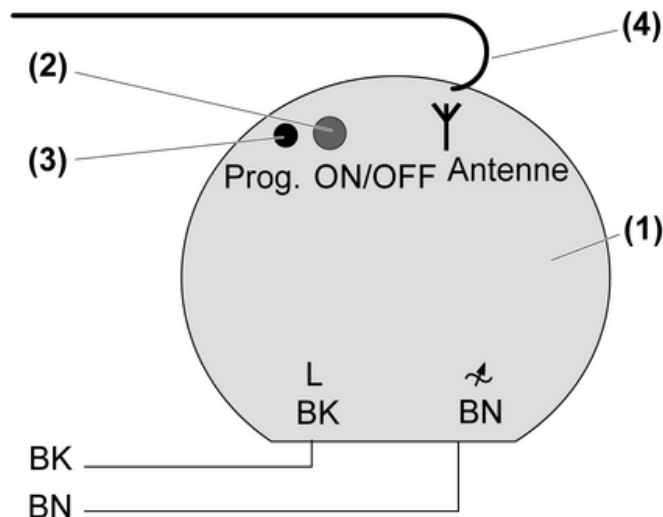

Figure 1

- (1) Dimmer
- (2) Programming button
- (3) LED
- (4) Antenna

3 Function

System information

By statute, the reception characteristics and the antenna cannot be changed.

The device may be operated in all EU and EFTA countries.

The declaration of conformity can be viewed on our website.

The range of a radio system from the transmitter to the receiver depends on various circumstances.

The range of the system can be optimised by selecting the optimal installation location, taking into account the structural circumstances.

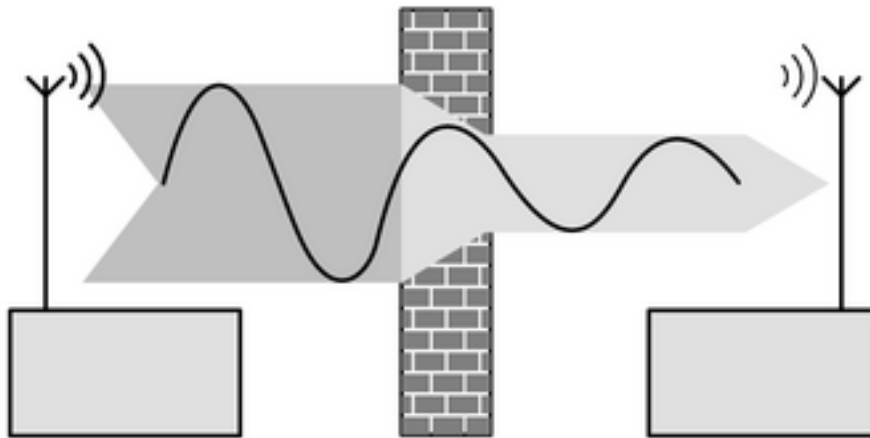

Figure 2: Reduced range due to structural obstacles

Example of penetration of various materials:

Material	Penetration
Wood, plaster, plasterboard	approx. 90%
brick, chipboard	approx. 70%
Reinforced concrete	approx. 30%
Metal, metal grid	approx. 10%
Rain, snow	approx. 1-40%

Intended use

- Radio-controlled switching and dimming of incandescent lamps, fluorescent lamps, HV halogen lamps, and Tronic or inductive transformers with halogen lamps.
- Operation with suitable radio transmitters
- Suitable for mixed operation up to the specified output (Technical data)
- Installation in appliance box to DIN 49073

i No mixed-load operation of Tronic and inductive transformers.

i It is not possible to teach a combination of presence detector and motion detector.

Product characteristics

- Switch-on via bulb-preserving soft start
- Switch-on brightness can be saved permanently
- Light scene operation possible
- Constant light regulation possible in connection with a radio presence detector
- Run-on time of approx. 1 minute in connection with radio motion detectors.
- Electronic short-circuit protection with permanent switch-off after 7 seconds at the latest
- Electronic over-temperature protection
- Automatic setting of the dimming principle suitable for the load.

Load type	Electrical behaviour	Dimming principle
Incandescent lamps	ohmic	Phase cut-off
HV halogen lamps	ohmic	Phase cut-off
Tronic transformers with halogen lamps	capacitive	Phase cut-off
Dimmable inductive transformers with halogen lamps	inductive	Phase cut-on

- i** Flickering of the connected lamps due to undershoot of the specified minimum load or through centralised pulses from the power stations. These are not device faults.
- i** Brief flickering upon load detection of ohmic loads. No operation is possible during load detection.

4 Operation

A radio transmitter has to be taught in order to be able to operate the dimmer.

- i** Observe the instructions for the radio transmitter.

5 Information for electrically skilled persons

5.1 Fitting and electrical connection



DANGER!

Electrical shock when live parts are touched.

Electrical shocks can be fatal.

Before carrying out work on the device or load, disengage all the corresponding circuit breakers. Cover up live parts in the working environment.

Connecting and mounting the dimmer

Maintain a distance of at least 0.5 m from metal surfaces and electrical devices, e.g. microwave ovens, hi-fi and TV systems, electronic ballasts or transformers.

Maintain a distance of at least 1 m between transmitter and receiver in order to prevent overmodulation of the receiver.

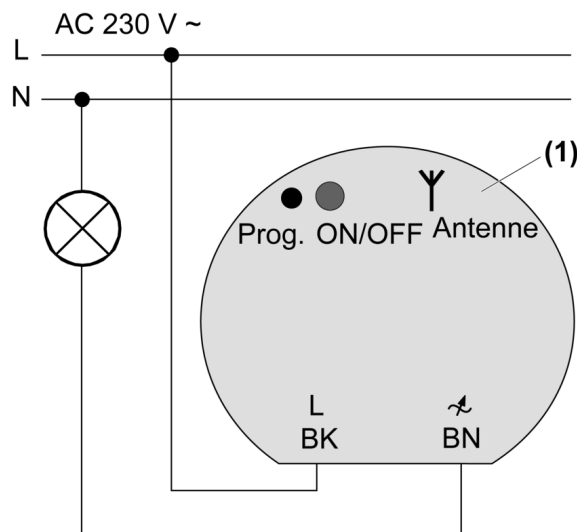

Figure 3

- Connect the dimmer (1) to lamp terminals according to connection diagram (figure 3) (see Using the lamp terminals).

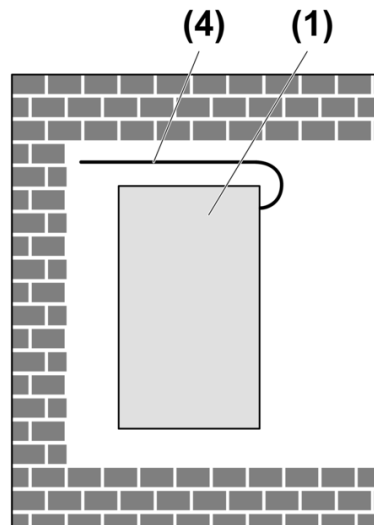

Figure 4

- Insert the dimmer in the appliance box in such a way that the programming button and the LED are visible.
 - Lay the antenna (4) stretched out freely if possible (figure 4).
 - Switch on mains voltage.
The dimmer automatically sets the dimming principle suitable for the load.
- i** The load can be switched on or off by pressing the programming button briefly (for about 1 second).

Using the lamp terminals

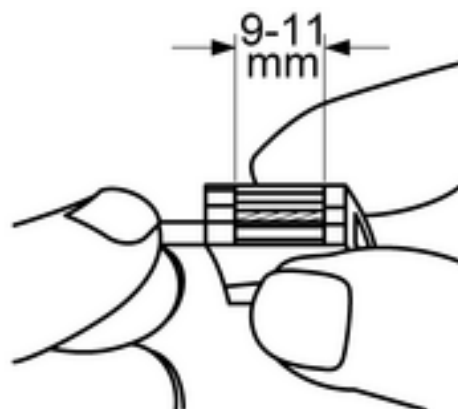

Figure 5: Stripping length

- Strip 9 - 11 mm of the cable (figure 5).

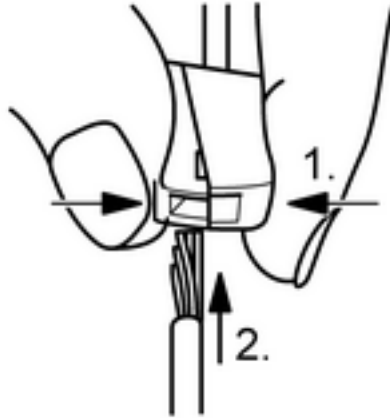

Figure 6: Connection of the fine-wire cable

- Push the terminal together on the side with the square opening and connect a fine-wire cable (figure 6).

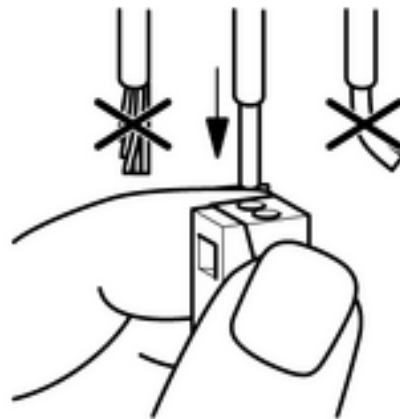

Figure 7: Connection of the single-stranded cable

- Push the single-stranded cable into the round opening on the installation side up to the stop (figure 7).

5.2 Commissioning

-  Observe the instructions for the radio transmitter.



DANGER!

Electrical shock when live parts are touched.

Electrical shocks can be fatal.

Before working on the device, cover up live parts in the working environment.

Teaching a radio transmitter

-  If all memory slots are occupied, a radio transmitter which has already been taught must first be deleted. To do this, delete all taught channels and light scenes of the radio transmitter individually.

The distance between the receiver and the radio transmitter is from 0.5 m to 5 m.

Load is switched off.

- Press the programming button for approx. 4 seconds.
The LED blinks. The device is in programming mode for approx. 1 minute.
- Trigger teach telegram on radio transmitter (see instructions for radio transmitter).

LED lights up. The radio transmitter has been taught.

- Press the programming button briefly.
The load switches on. The device is in operating mode.
- i** The programming mode is exited automatically after about 1 minute.
- i** Teach light scene buttons separately.
- i** When a radio transmitter is taught, All On and All Off buttons that are present are automatically also taught.

Save switch-on brightness

A set brightness value can be saved in the dimmer as the switch-on brightness.

- i** In the state as supplied the switch-on brightness is set to maximum.
 - Set light to the required brightness.
 - Press programming button for longer than 4 seconds.
Switch-on brightness is saved. For confirmation the lighting switches off briefly and then on again.
- i** The saved switch-on brightness is retained in the event of a power failure.

Deleting radio transmitters individually

- Teach the radio transmitter to be deleted again (see Teaching a radio transmitter).
LED blinks quickly. The radio transmitter has been deleted.
- i** If several channels or light scenes of a radio transmitter have been taught, they all must be deleted individually.

Deleting all radio transmitters

Load is switched off.

- Press the programming button for approx. 20 seconds.
After approx. 4 seconds the LED blinks.
After approx. 20 seconds the LED flashes.
- During the next 6 seconds, release the programming button and press it again for approx. 1 second.
LED lights up. The radio transmitters will be deleted.
LED blinks quickly. All radio transmitters have been deleted.

6 Appendix

6.1 Technical data

Rated voltage	AC 230 V ~
Mains frequency	50 / 60 Hz
Ambient temperature	+5 ... +45 °C
Relative humidity	approx. 15 % ... 50 % (No moisture condensation)

Connected load at 35 °C

- i** Power specifications including transformer power dissipation.
- i** Operate inductive transformers with at least 85% nominal load.
- i** For ohmic-inductive mixed load, maximum 50% proportion of ohmic load. Otherwise incorrect calibration of the dimmer may result.

Incandescent lamps	50 ... 210 W
HV halogen lamps	50 ... 210 W
Tronic transformers	50 ... 210 W
Inductive transformers	50 ... 210 VA
Ohmic-inductive	50 ... 210 VA
ohmic-capacitive	50 ... 210 W
capacitive-inductive	not permitted

Power reduction

per 5°C in excess of 35°C	-10 %
Power boosters	none
Connection	
Single stranded	1.0 ... 2.5 mm ²
Dimensions Ø×H	52.5×27.5 mm
Total length power cable	max. 100 m
carrier frequency	433.42 MHz (ASK)
Teachable radio transmitter	max. 30



The symbols used to label the dimmer load shows the load type that can be connected to a dimmer and the electric behaviour of a load:
R = ohmic, L = inductive, C = capacitive

6.2 Troubleshooting

The dimmer switches the load off briefly and then on again.

Cause: short-circuit protection has tripped but now there is no longer a fault.

The dimmer switches the load off and cannot be switched on again.

Cause 1: electronic short-circuit protection has tripped.

Eliminate short-circuit.

i The electronic short-circuit protection is not based on a conventional fuse, no electrical isolation of the load circuit.

Cause 2: overheating protection has tripped.

Disconnect dimmer from mains, also switch associated off circuit breakers.

Let dimmer cool down for at least 15 minutes.

Check the installation situation.

Reduce the connected load.

Switch circuit breakers and dimmer on again.

Dimmer does not respond, or only sometimes.

Cause 1: battery in the transmitter is empty.

Change the battery.

Cause 2: radio range has been exceeded. Structural obstacles reduce the range.

Check the installation situation.

Check routing of antenna. Laying the antenna stretched out increases the range.

Using a radio repeater.

6.3 Warranty

We reserve the right to make technical and formal changes to the product in the interest of technical progress.

We provide a warranty as provided for by law.

Please send the unit postage-free with a description of the defect to our central customer service office:

ALBRECHT JUNG GMBH & CO. KG

Service Center
Kupferstr. 17-19
D-44532 Lünen
Service-Line: +49 (0) 23 55 . 80 65 51
Telefax: +49 (0) 23 55 . 80 61 89
mail.vka@jung.de

General equipment

Service-Line: +49 (0) 23 55 . 80 65 55
Telefax: +49 (0) 23 55 . 80 62 55
mail.vkm@jung.de

KNX equipment

Service-Line: +49 (0) 23 55 . 80 65 56
Telefax: +49 (0) 23 55 . 80 62 55
mail.vkm@jung.de

The € symbol is a free trade symbol, which is solely intended for the authorities and does not guarantee any properties.

ALBRECHT JUNG GMBH & CO. KG

Volmestraße 1
D-58579 Schalksmühle

Telefon: +49.23 55.8 06-0
Telefax: +49.23 55.8 06-1 89
E-mail: mail.info@jung.de
Internet: www.jung.de
www.jung-katalog.de