



Product documentation

Facility Colour Touch Panel IP
Art.-No.: FP 701 CT IP



ALBRECHT JUNG GMBH & CO. KG
Volmestraße 1
D-58579 Schalksmühle

Telefon: +49.23 55.8 06-0
Telefax: +49.23 55.8 06-1 89
E-mail: mail.info@jung.de
Internet: www.jung.de
www.jung-katalog.de

Issue: 10.03.2011
13557020

Contents

1	Product definition	4
1.1	Product catalogue	4
1.2	Function	4
1.3	Accessories	5
2	Fitting, electrical connection and operation	6
2.1	Safety instructions	6
2.2	Device components	7
2.3	Fitting and electrical connection	8
2.4	Commissioning	10
2.5	Operation	12
3	Technical data	14
4	Software description	15
4.1	Software specification	15
4.2	Software "...590101"	16
4.2.1	Scope of functions	16
4.2.2	Software information	18
4.2.3	Object table	19
4.2.4	Functional description	37
4.2.4.1	Basic settings during project planning	37
4.2.4.1.1	General parameters	37
4.2.4.1.2	LCD lighting	42
4.2.4.1.3	Date and time	43
4.2.4.1.4	Download behaviour	45
4.2.4.1.5	Colour schemes	46
4.2.4.1.6	Image list	47
4.2.4.1.7	Preview and resource monitor	49
4.2.4.2	Screen pages	50
4.2.4.2.1	General page structure	50
4.2.4.2.2	Display elements	54
4.2.4.2.3	Status line	64
4.2.4.2.4	Copying display elements and pages	65
4.2.4.2.5	Connecting pages	66
4.2.4.3	Service page	67
4.2.4.3.1	Structure	67
4.2.4.3.2	Display and system settings	68
4.2.4.3.3	Administrator settings	70
4.2.4.3.4	Passwords	75
4.2.4.3.5	IP settings	76
4.2.4.4	Fault messages	79
4.2.4.4.1	Creating fault messages and the message window	79
4.2.4.4.2	Acknowledgement and message list	81
4.2.4.5	Light scene function	83
4.2.4.5.1	Adding light scenes and light scene groups	83
4.2.4.5.2	Specifying light scene values	85
4.2.4.6	Timer switch function	87
4.2.4.6.1	Creating timer switch channels	87
4.2.4.6.2	Setting switching times	89
4.2.4.6.3	Astro and random function	92
4.2.4.7	Timers	94
4.2.4.8	Logical links	95
4.2.4.9	Multiplexer	97
4.2.4.10	Datalogger	99
4.2.4.10.1	Datalogger recording	99

4.2.4.10.2 Datalogger display	103
4.2.4.11 Presence simulation	105
4.2.4.11.1 Recording a telegram sequence	105
4.2.4.11.2 Playing a telegram sequence back	108
4.2.4.12 Signalling system	110
4.2.4.12.1 Introduction and basic principles	110
4.2.4.12.2 Detector	115
4.2.4.12.3 Arming	119
4.2.4.12.4 Alarms	122
4.2.4.12.5 Fault	124
4.2.4.12.6 Event memory	125
4.2.4.12.7 Behaviour after a device reset	126
4.2.4.13 e-mail messages	127
4.2.4.13.1 Introduction	127
4.2.4.13.2 Displaying e-mail messages	128
4.2.4.13.3 Sending e-mail messages	132
4.2.4.14 RSS newsfeeds	134
4.2.4.14.1 Introduction	134
4.2.4.14.2 Displaying RSS newsfeeds	135
4.2.4.15 Group addresses	139
4.2.4.16 Options of the ETS plug-in	140
4.2.5 Parameters	141
4.3 PC Client software	205
4.3.1 Introduction, installation and program start	205
4.3.2 Connection settings, data exchange and device update	207
4.3.3 Configuration data (IP, e-mail, RSS)	211
4.3.4 Remote operation	219
5 Appendix	221
5.1 Index	221

1 Product definition

1.1 Product catalogue

Product name: Facility Colour Touch Panel IP

Use: Controller

Design: uP (flush-mounting type)

Art.-No.: FP 701 CT IP

1.2 Function

The panel is used to display statuses with an KNX/EIB installation and to control system functions. The display elements are shown on a colour TFT monitor at a resolution of 320 x 240 pixels (5.7" / 4,096 colours). The operating elements are controlled by touching the TFT monitor (touch screen).

Up to 50 freely-programmable screen pages, each with up to 16 display elements, can be used for operation and displaying. The maximum total amount of display elements in the panel is 400. Up to four programmable function keys can be allocated to each display element. Both basic functions, such as switching, dimming and blinds, and also complex functions such as value encoders, date, limit values, etc., can also be configured.

Coloured images, in BMP and JPG format, can be included as wallpapers to aid desktop design, and can also be used as icons.

The panel also possesses an Ethernet interface. Various embedded IP protocols allow up to five synchronised and password-protected mailboxes and the text contents of e-mails to be opened. It is also possible to send predefined e-mails. In addition, RSS news feeds can be displayed on the panel's colour display.

The display and operating functions of the panel can be visualised 'from a distance' using easy-to-install PC Client software and can be operated simultaneously (remote communication). The Ethernet interface also permits user-orientated configuration and commissioning of the panel.

A synchronisable real-time clock is available for setting up time switch functions and for logging events. Events or any other actions can be forwarded by a switching command using predefined e-mails. In addition, the panel can be programmed with up to 24 light scenes with 32 actuator groups.

In addition, the panel can be used to implement a presence simulation and a datalogger functionality. The presence simulation can, for example give those outside the impression that a house is lived in, even though the owners are away. The owners can record any simulations over periods of time and play them back at any time.

The datalogger provides the option of recording data, received from the KNX/EIB, in various formats, and displaying them on the unit. The data recorded by the datalogger can also be forwarded by e-mail.

If necessary, a signalling system can provide a security-orientated system to monitor doors and windows. Up to two different signalling areas (internal / external) can be armed and monitored for break-ins and sabotage. Thus visual and acoustic alarming is possible using additional KNX/EIB components (e.g. switching actuators) in conjunction with alarm encoders (flash light, internal siren).

There are appropriate special pages set up for timer switch functions, e-mail boxes, light scenes, fault messages, message list, signalling system and the setup of system functions. Four password levels allow controlled access to different functions. For this one of four password levels can be allocated to each screen.

Commissioning can take place both via the bus and via an integrated USB port and also, to a certain extent, via the Ethernet port. The panel can be installed horizontally (preferred) or vertically.

1.3 Accessories

Flush-mounted recessed box
Frame for facility panel

Art.-No.: EBG 24
Art.-No.: .. 781 ..

2 Fitting, electrical connection and operation

2.1 Safety instructions

Electrical equipment may only be installed and fitted by electrically skilled persons. The applicable accident prevention regulations must be observed.

Before working on the device or exchanging the connected loads, disconnect it from the power supply (switch off the miniature circuit breaker), otherwise there is the risk of an electric shock.

Do not operate the screen with sharp or pointed objects. The touch-sensitive surface may be damaged.

Do not use sharp objects for cleaning. Do not use sharp cleaning agents, acids or organic solvents.

Failure to observe the instructions may cause damage to the device and result in fire and other hazards.

2.2 Device components

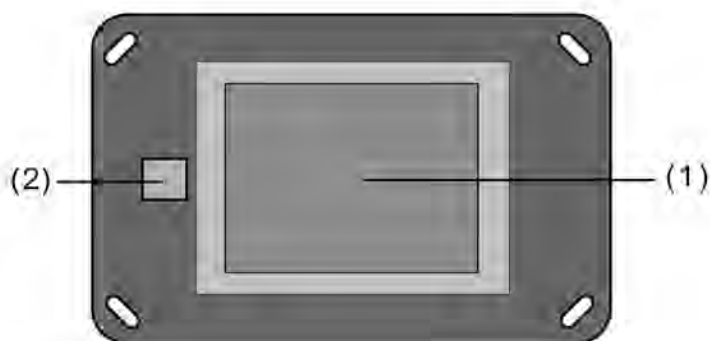

Figure 1: Device components, front side

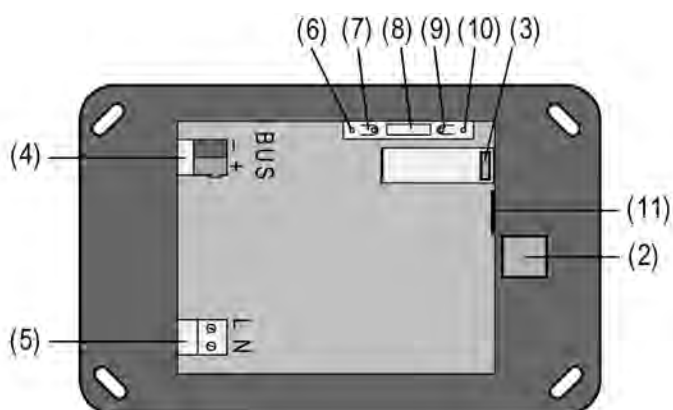

Figure 2: Device components, rear side

- (1) Colour TFT monitor (touch screen)
- (2) USB connection on the front side of the device (USB type B connector / located behind the design cover)
- (3) USB connection on the rear side of the device (flat connector / run to the front of the device using a flat cable)
- (4) KNX/EIB bus connection
- (5) Mains voltage connection
- (6) Programming LED (red)
- (7) Programming key
- (8) **Ext.** connection for extensions, e.g. external button
- (9) Reset button
- (10) Reset LED (red)
- (11) 8-pin Ethernet connection sockets

i The programming button and LED are only accessible from the rear side of the device. If possible load the physical address into the device before final mounting (see chapter 2.4. Commissioning).

Dimensions:
 approx. width (B): 220 mm / height (H): 140 mm / depth (D): 48 mm
 Without decorative cover frame and concealed installation housing.

2.3 Fitting and electrical connection



DANGER!

Electrical shock when live parts are touched.

Electrical shocks can be fatal.

Before working on the device, disconnect all the corresponding miniature circuit breakers. Cover up live parts in the working environment.

Connecting and mounting the device

- Mount the installation housing (12) in the right position - aligned horizontally or vertically - in the wall (masonry or cavity wall).
Horizontal mounting: arrow **TOP** points upwards. Vertical mounting: arrow **TOP** points left. Insert bus and 230 V cables, and, as necessary, Ethernet connection cable through the appropriate openings in the housing.
- i** Recommendation: mount at eye level for optimum reading.
- i** During installation, use the original installation housing (Jung article no. EBG 24), in order to maintain the protection class II.
- Pull the included hose over the unjacketed mains voltage wires. Mount the KNW/EIB connection terminal to the bus cable.
- Connect mains voltage AC 230 V ~ to the terminals **L N** (5).
- Connect bus cable to the **BUS** terminal (4).
- If the device is to be connected to a local network, the Ethernet connection should also be setup.
 - For Ethernet connections with a standard installation cable:
Connect the Ethernet cable provided in the packaging to the Ethernet adapter connector ('Keystone'). Remove the jacketing of the Ethernet cables, do not remove the insulation and insert it in the lid of the adapter connector. In so doing, ensure correct polarity (colour assignment of the wire pairs in the installation and on the connection adapter EIA/TIA-568-A or -B). Cut off any excess wire and push the lid onto the adapter connector correctly. Then, insert one end of the enclosed mini patch cable into the Ethernet socket of the panel and the other into the mounted Ethernet adapter connector.
 - For Ethernet connection with a standard patch cable:
Insert the patch cable directly into the Ethernet connection socket of the panel.
- i** The pins of the Ethernet connection integrated in the table are assigned according to EIA/TIA-568-B.

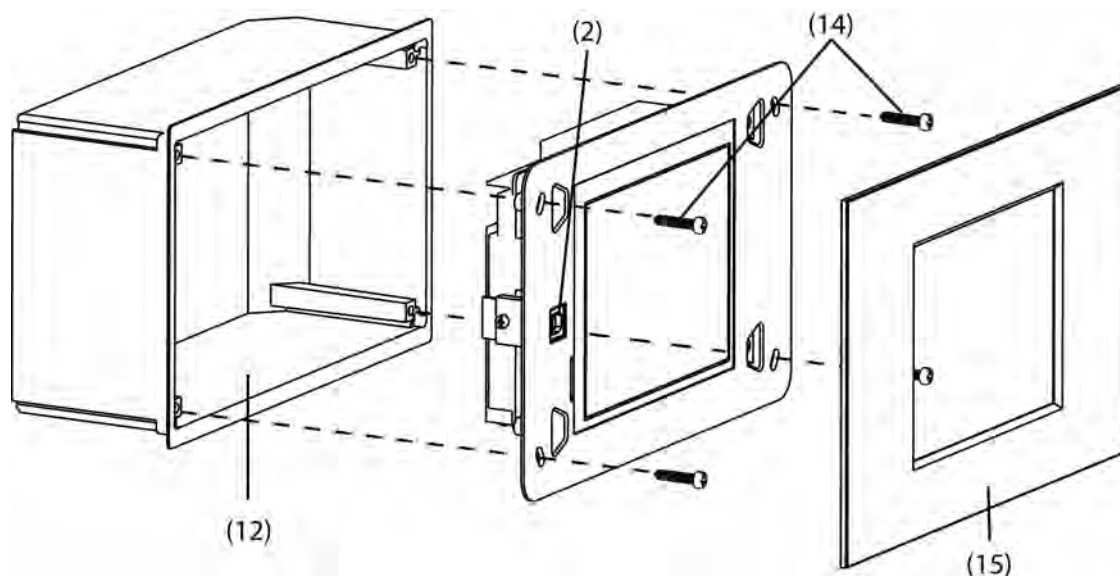

Figure 3: Mounting with installation housing and decorative cover

- Insert the device in the installation housing (12) and fix it. Use the screws (14) provided.
- i** Before inserting the device in the installation housing, load the physical address to the device using the ETS (see chapter 2.4. Commissioning).
- i** Before inserting the device in the installation housing, ensure that no cables are crushed or bent.
- Attach the decorative frame (15) and push it on.
- i** Do not attach the decorative frame if the device is still to be programmed with the project planning data after mounting. The USB connection socket of the panel must be accessible on the front of the device.

Connecting external buttons

If required, external buttons can be connected. To connect external buttons, use the button cable (available separately) (article no, 701 CTTL). Note the maximum cable length is 1.20 m.

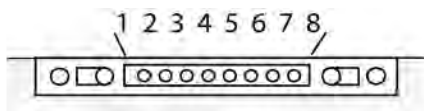

Figure 4: Connection socket for external buttons

- Connect the button to the button cable. Ensure the correct binding. The button reference potential is "**GND**".
- Attach the button cable to the "**Ext.**" connection (8). Observe the pin assignment (figure 4).

Pin no.	Function
1	GND
2	Button 1 - Up arrow
3	Button 2 - Down arrow
4	Button 3 - Function button 1
5	Button 4 - Function button 2
6	Button 5 - Function button 3
7	Button 6 - Function button 4
8	Not assigned

- i** Buttons 1 & 2 are used to navigate between the display elements on the screen. Buttons 3, 4, 5, & 6 behave like the four function buttons on the display desktop. The button functions are triggered when the function buttons in the display are invisible (see chapter 4.2.4.2.2. Display elements).
The following elements cannot be operated with an external keyboard: inputting numbers via the numeric keypad (e.g. password, timer switch, limit values). Text input (e.g. light scene names). Changing a value via the bar graph (editing values in the gar graph display). It is only possible to operate and exit the value and text editing pages using the touch display.

2.4 Commissioning

Commissioning

After installation of the device and connection of the bus line, the mains supply and, if necessary, of the Ethernet cable, the device can be put into operation. Commissioning coil actuator is essentially confined to the installation of the USB driver and device programming via the ETS. The following procedure is generally recommended...

Install the USB drivers

Commissioning the panel may take some time, depending on the scope of project planning. To shorten the loading time of the application and all the project planning data, we recommend programming the device directly via USB. To allow USB device programming, a USB driver must be installed on the commissioning PC.

To ensure correct installation of the USB driver, the panel must not be connected to the PC before installing the driver. The driver required for USB programming is supplied together with the project planning software (plug-in) of the panel. When the project planning software has been completed, there is the option of installing the USB driver automatically.

- Install the project planning software of the panel. At the end of the installation process, start the automatic USB driver installation application.
- i** Two drivers are installed during automatic installation. Firstly, the actual USB driver is installed, and immediately after that a virtual COM port is installed, which is important for the USB connection of the panel to function correctly. For this reason, do not cancel the installation after the first step!
- i** The appropriate access rights in the operating system are required for driver installation.
- i** Some PC operating systems test during installation whether the USB drivers have certificates. The appropriate messages can be ignored and installation continued.

Programming the physical address

The physical address is programmed using a KNX/EIB data interface in the ETS programming.

The programming button (7) and LED (6) must be accessible on the rear side of the device.

In addition, the project planning software must be installed and an appropriate device inserted in the project in the ETS and a physical address assigned.

- Switch on the mains supply to the device.
The device switches the display on and shows the Start screen. The Start screen remains visible if the device has not yet been commissioned (default setting). Otherwise the old project planning is displayed after a few seconds.
- Press the programming key (7).
The programming LED (6) is illuminated.
- Program the physical address with the help of the ETS.
The Programming LED (6) goes out if programming has been successful.
- Note the physical address on the rear side of the device.
- i** When the physical address has been programmed, the device can finally be mounted.

Programming the application program and the project planning data

When the physical address has been programmed, the application program and all the project planning data must be programmed into the device. It is always wise to connect the device directly to the commissioning PC via the integrated USB interface, as there are large volumes of data to be loaded into the device, particularly during first commissioning. A USB programming operation shortens the loading time and must be started directly from the project planning software (plug-in) via the "Download" menu. Start the project planning software by opening the

device parameter view in the ETS. The ETS programming function (USB or RS232 data interface) cannot be used for USB programming of the panel.

The USB driver must have been installed successfully in advance of this.

Only one panel may be connected to the commissioning PC by USB at any one time.

If necessary, remove the decorative frame (15) attached during mounting from the front of the device.

- If you have not already done so, switch on the mains supply to the device.
The device switches the display on and shows the Start screen. The Start screen remains visible if the device has not yet been commissioned (default setting). Otherwise the old project planning is displayed after a few seconds.
- Connect the commissioning PC to the USB socket of the panel (2) with a suitable USB connection cable (type A -> type B).
The USB driver is initialised by the PC operating system.
- Launch the panel's project planning software in the ETS. (Open the parameter view of the appropriate device).
- Configure the device using the project planning software.
- When project planning has been completed, carry out the USB programming operation in the "Download" menu. This process may take several minutes.
The progress of the programming operation is shown in the display of the panel. When the programming operation has been completed, the display is initialised automatically. The Start screen is displayed during initialisation.
- Disconnect the USB cable attach the decorative frame (15).
- This completes the commissioning process.

i If, after first commissioning, only small changes need to be made to the device project planning, the project planning data can be downloaded both via the bus line (communication data interface of the ETS - Command "Program application program") or, as described, using the project planning software via the USB interface of the panel. When making changes to the wallpapers of the icons for the display / status elements, we recommend a direct connection to the USB interface of the panel.

2.5 Operation

Operation

The functionality and the appearance of the monitor desktop depends on the programming and thus varies for each system. The possible elements on a screen page show status information, provide values of other information or are programmed for operation (figure 5).

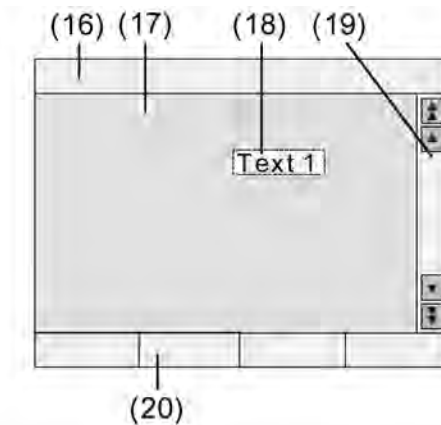

Figure 5: Monitor elements

- (16) Status line
- (17) Screen page
- (18) Operating or display element
- (19) Scroll bar
- (20) Function keys

Sensoric surface (touch screen)

The monitor possesses a sensoric surface, also know as a touch screen. The device is operated by touching the monitor surface with your finger or with special touch screen pens (not contained in the scope of supply).

- i** Do not use sharp objects for operation. The surface may be damaged and thus operation impeded.

Status line

When configured in the ETS, the status line (16) can be seen on the top edge of the screen. The status line can display up to ten elements of the following functions...

- Event display
- Collective fault message
- Value display
- Date
- Time
- ASCII text

Screen page

Operating and display elements (18) are displayed on the screen pages (17)...

- Display elements display the statuses of components (e.g. lighting systems, heating or air conditioning systems, shading controls).

- Operating elements are used for navigation or symbolise devices, components and functions to be controlled.
- Wallpapers can be stored on any screen page.

Function keys

There are a maximum of four function buttons (20) available for each operating element (18), which can be displayed and operated after selecting the operating element. You can configure in the ETS whether the function buttons for an operating element are visible on the screen or not.

3 Technical data

General

Mark of approval	KNX / EIB
Storage/transport temperature	-25 ... +75 °C (Storage above +45 °C reduces the lifetime.)
Ambient temperature	-5 ... +45 °C
Fixing type	Installation in flush-mounted box (e.g. small distribution board, etc.)
Dimensions WxHxD	approx. 220x140x48 mm (without design frame)

Terminals for mains supply

Connection mode	Screw terminal
Single stranded	0.5 ... 2.5 mm ²
finely stranded with conductor sleeve	0.5 ... 1.5 mm ²
finely stranded without conductor sleeve	0.5 ... 2.5 mm ²

External supply

Rated voltage	AC 230 V ~
Mains frequency	50 / 60 Hz
Power consumption	approx. 13.8 W
Standby power	approx. 5 W

KNX / EIB supply

KNX medium	TP 1
Commissioning mode	S-mode
Rated voltage KNX	DC 21 ... 32 V SELV
Current consumption KNX	max. 10 mA
Connection mode KNX	Connection terminal

USB

Number	1
Version:	2.0
USB connection	Type B

Ethernet

Number	1
Type	10 MBit/s Ethernet
Connection	RJ45-socket 8/4-pin
Protocols	TCP/IP, IMAPv4, POP3, SMTP
DHCP	possible (set to active at the factory), AutoIP

Internal clock module (RTC)

Power reserve	min. 12 hours
Rate deviation	<2 min/month
Supply	Gold Cap fed from mains voltage supply

External connection

External connection	ready-made connector
Connection	8-pin plug connector
Cable length	max. 1.20 m

4 Software description

4.1 Software specification

ETS search paths: Display / LCD displays / Facility Colour Touch Panel IP

BAU used: TPUART + μ C
KNX/EIB type class: 3g device with cert. PhL + stack + μ C
Configuration: S mode with plug-in
PEI type: "0A"_{Hex} / "10"_{Dec}
PEI connector: No connector

Application program:

No.	Short description	Name	Version	from mask version
1	Panel with coloured touch display.	Facility Colour Touch Panel IP 590101	0.1	701

4.2 Software "...590101"

4.2.1 Scope of functions

Scope of functions

- The panel is used to control building functions and to display building statuses of various features.
- The panel can be used both in landscape format and in portrait format. The selected installation position is entered in the project planning software (ETS plug-in). The space for arranging the display elements is dependent on this.
- Image files in BMP or JPG format can be included as a background, a display icon or status display. Eight configurable colour schemes allow adaptation of the graphic display.
- Up to 400 display elements can be shown on up to 50 freely-programmable screen pages. Each page can display up to 16 display elements. The screen pages can be selected and displayed using a separate KNX/EIB communication object.
- A scrollbar allows navigation between the screen pages and the display elements contained within.
- Up to four function buttons can be allocated to each display element. These function buttons can be directly linked to the function of a display element or can trigger independent functions. Independent functions include: switching, dimming, blinds, value, light scene, restraints, DALI error status. In addition, you can use the function buttons to navigate between screen pages.
- The display elements can be configured to the functions switching, dimming, blinds, value display with various variables, light scene control, date, time, text display, datalogger display, access check, restraint, operating mode switch of a heating/cooling system, collective feedback or load type of a dimmer actuator.
- The panel possesses an Ethernet interface. Various embedded IP protocols allow up to five synchronised and password-protected mailboxes and thus the text contents of e-mails to be opened and written.
- Display of up to eight RSS newsfeeds (RSS 2.0) in colour on the panel display.
- The display and operating functions of the panel can be visualised 'from a distance' using easy-to-install PC Client software and can be operated (remote communication). The Ethernet interface also permits user-orientated configuration and commissioning of the panel.
- Four password levels allow protection against unauthorised access to the screen pages or e-mail mailboxes.

- There is a weekly timer switch with up to 16 channels. The individual channels can be used for different functions (switching, values, light scenes, operating mode switching). A random and an astro function can be activated optionally on each timer switch channel. The switching times are programmed in the ETS or directly on the panel after commissioning.
- Up to 24 light scenes with a total of 32 actuator groups can be created. The light scenes are set directly on the panel after commissioning.
- There are up to 80 logical links available, each with up to 8 inputs, up to 12 multiplexers each with up to three channels and 40 timers with ON delay and OFF delay and a filter function.
- Up to 50 different fault messages can be used. Of these fault messages, up to 20 can be active simultaneously. Activation, acknowledgement and deactivation of fault messages can be logged in a message list.
- A synchronisable real-time clock is available for setting up time switch functions and for logging events. The events can be forwarded by a switching command using predefined e-mails.
- A presence simulation allows the recording or playing back of any simulations over specific periods of time.
- A datalogger provides the option of recording data, received from the KNX/EIB, in various formats, and displaying them on the unit. The data recorded by the datalogger can also be forwarded by e-mail.
- If necessary, a signalling system can provide a security-orientated system to monitor doors and windows. Up to two different signalling areas (internal / external) can be armed and monitored for break-ins and sabotage. Thus visual and acoustic alarming is possible using additional KNX/EIB components (e.g. switching actuators) in conjunction with alarm encoders (flash light, internal siren).
- Project planning takes place with an ETS plug-in. Commissioning can take place both via the ETS and via the plug-in. Programming via the plug-in can save considerable time on account of the access to the internal USB interface of the panel.

4.2.2 Software information

Information on configuration and commissioning

The ETS application described in this documentation and carrying the number "...5901 0.1" including the plug-in is used to configure the device with the Jung article no. FP 701 CT IP (Facility Colour Touch Panel IP with Ethernet interface).

The so-called application can also be programmed in older device variants (Facility Colour Touch Panel / Jung article no. FP 701 CT). In this case, the firmware in the old device must be updated. This update is carried out automatically by the plug-in after a user confirmation. In this way, updated old devices can have the functionality of the new firmware. Only the IP functionality (remote operation, e-mail, RSS feeds, etc.) is not available due to the fact that there is no Ethernet interface in the old devices.

The firmware makes the following functions available:

- Presence simulation
- Signalling system
- Datalogger
- Timer switch: astro and random function, preconfiguration of the switching times in the ETS plug-in
- Static icons for display elements
- Extended positioning parameters for display elements
- Display functions, collective feedback and dimmer actuator load type
- Internal clock: Master function
- Open page via object
- Character sets can be selected for user pages

Device variants older than those above cannot be programmed using the application and the plug-in described in this documentation.

Plug-in project planning data of older device variants - for example from existing ETS projects - can be inserted into the ETS plug-in of newer devices via a template export and import and then extended as required according to the new functionality. It is not possible to transport templates from the application of newer devices into the plug-in of older ones.

4.2.3 Object table

Number of communication objects:	max. 2.000 Generated dynamically
Number of addresses (max):	3.000
Number of assignments (max):	3.000
Dynamic table management:	No
Maximum table length:	----

The communication objects are generated dynamically by the ETS plugin according to requirements. Within the ETS (Project view) all the objects described below are displayed as collective objects with allocated group addresses, depending on the data format. Group addresses may only be linked to communication objects in the plug-in.

Objects for general functions

Function: Acoustic signal

Object	Function	Name	Type	DPT	Flag
<input type="checkbox"/> ←	Sound output	Acoustic signal	1 bit	1.001	C, S

Description 1 bit object, using which the piezo buzzer can be switched on and off. If this object is used, all the automatic signal tones (e.g. for fault messages) are suppressed..
0 = Buzzer off / 1 = Buzzer on

Function: Automatic time setting

Object	Function	Name	Type	DPT	Flag
<input type="checkbox"/> ←	Date / Time	Automatic time setting	1 bit	1.001	C, S

Description 1 bit object, via which the summer / winter time setting can be carried via the bus.
0 = Winter time / 1 = Summer time

Function: Display lighting

Object	Function	Name	Type	DPT	Flag
<input type="checkbox"/> ←	LCD lighting	Lighting object	1 bit	1.001	C, S

Description 1 bit object, using which the display background lighting can be switched off and on. The telegram polarity can be configured.
After a time settable in the plug in has elapsed, the lighting automatically switches back to the basic level of brightness.

Function: Date / time request

Object	Function	Name	Type	DPT	Flag
<input type="checkbox"/> ←	Request	Request date / time	1 bit	1.001	C, T

Description 1 bit object, using which a request telegram for the data and time on the KNX/EIB can be transmitted (depending on parameters). In this way, the panel can poll the date and current time from another bus subscriber, e.g. Master clock. The response of the master is then expected via the objects "MasterDate" and "MasterTime".
The request is made after a restart and then every night at 4.00 am. The telegram polarity can be configured.

Function: Date

Object	Function	Name	Type	DPT	Flag
<input type="checkbox"/> ←	Transmit	Date object	3 byte	11.001	C, W, T

Description 3 byte object with which the panel can send the internal date to the bus cyclically or on request.

Function: Master clock date

Object	Function	Name	Type	DPT	Flag
<input type="checkbox"/> ←	External comparison	Master date	3 byte	11.001	C, W, T

Description 3 byte object, with which the panel can receive the current date from a KNX/EIB master clock for synchronisation (parameter-dependent).

Function: Master clock time

Object	Function	Name	Type	DPT	Flag
<input type="checkbox"/> ←	External comparison	Master time	3 byte	10.001	C, W, T

Description 3 byte object, with which the panel can receive the current time from a KNX/EIB master clock for synchronisation (parameter-dependent). The weekday information can also be obtained from the time telegram.

Function: Time

Object	Function	Name	Type	DPT	Flag
<input type="checkbox"/> ←	Transmit	Time object	3 byte	10.001	C, W, T

Description 3 byte object with which the panel can send the internal time to the bus cyclically or on request. The weekday information can also be transmitted with the time telegram.

Function: Date / time request by external device

Object	Function	Name	Type	DPT	Flag
<input type="checkbox"/> ←	Date / Time	Request date / time by external device	1 bit	1.001	C, S

Description 1 bit object, using which the panel can receive a request telegram from another KNX/EIB subscriber (depending on parameters). The panel responds to an external poll by transmitting the data and/or time telegram via the "Date object" and "Time object" objects. You can use the plug-in to configure which of these telegrams is sent. The telegram polarity of the external poll telegram can be configured.

Function: Open page

Object	Function	Name	Type	DPT	Flag
<input type="checkbox"/> ←	General	Open page	1 byte	5.010	C, W, T

Description 1 byte object, allowing direct opening of specifically-created pages and optionally all system pages. An opened page immediately appears on the device display. Each page can be opened individually using an allocated telegram value. An overview of all the telegram values can be seen in the chapter "Function description" of this documentation.

Object for display elements and/or function buttons and for the timer switch (only partially)

Function: Switching function

Object	Function	Name	Type	DPT	Flag
<input type="checkbox"/> ←	Switching	Switching object	1 bit	1.001	C, W, T

Description 1 bit object to transmit and receive switching telegrams

Function: Dimming functions

Object	Function	Name	Type	DPT	Flag
<input type="checkbox"/> ←	Dimming	Switching object	1 bit	1.001	C, W, T

Description 1 bit object to transmit and receive switching telegrams

Function: Dimming functions

Object	Function	Name	Type	DPT	Flag
<input type="checkbox"/> ←	Dimming	Dimming object	4 bit	3.007	C, W, T

Description 4-bit object to transmit and receive dimming telegrams for relative dimming.

Function: Dimming functions

Object	Function	Name	Type	DPT	Flag
	Dimming	Value object	1 byte	5.001	C, W, T

Description 1 byte object to transmit and receive value telegrams. These values can be displayed either as numeric values (0 ... 255) or as percentages (0 ... 100%).

Function: Blind/roller shutter control function

Object	Function	Name	Type	DPT	Flag
	Blind	Long-time object	1 bit	1.008	C, W, T

Description 1 bit object for moving (long-time operation) roller blinds and similar drives.

Function: Blind/roller shutter control function

Object	Function	Name	Type	DPT	Flag
	Blind	Short-time object	1 bit	1.007	C, W, T

Description 1 bit object for stopping and stepped adjustment (short-time operation) of blinds and similar drives.

Function: Value function

Object	Function	Name	Type	DPT	Flag
	Value	2 byte object (DPT 9.001 ... 9.021)	2 byte	9.001... 9.021	C, W, T

Description 2 byte object to transmit and receive floating values.

Function: Value function

Object	Function	Name	Type	DPT	Flag
	Value	1 byte object (DPT 5.001 ... 5.004)	1 byte	5.001... 5.004	C, W, T

Description 1 byte object to transmit and receive values. These values can be displayed or specified either as numeric values (0 ... 255), as percentages (0 ... 100%) or as angles (0 ... 360°).

Function: Value function

Object	Function	Name	Type	DPT	Flag
	Value	4 byte object (DPT 14.000 ... 14.079)	4 byte	14.000 ...14.079	C, W, T

Description 4 byte object to transmit and receive floating values.

Function: Value function

Object	Function	Name	Type	DPT	Flag
	Value	2 byte object (DPT 7.001)	2 byte	7.001	C, W, T

Description 2 byte object to transmit and receive counter values. The received value can be adapted to the required format before being displayed.

Function: Value function

Object	Function	Name	Type	DPT	Flag
	Value	2 byte object (DPT 8.001)	2 byte	8.001	C, W, T

Description 2 byte object to transmit and receive counter values. The received value can be adapted to the required format before being displayed.

Function: Value function

Object	Function	Name	Type	DPT	Flag
	Value	4 byte object (DPT 12.001)	4 byte	12.001	C, W, T

Description 4 byte object to transmit and receive counter values. The received value can be adapted to the required format before being displayed.

Function: Value function

Object	Function	Name	Type	DPT	Flag
	Value	4 byte object (DPT 13.001)	4 byte	13.001	C, W, T

Description 4 byte object to transmit and receive counter values. The received value can be adapted to the required format before being displayed.

Function: Value function

Object	Function	Name	Type	DPT	Flag
	Value	1 byte object (DPT 5.010)	1 byte	5.010	C, W, T

Description 1 byte object to transmit and receive counter values. The received value can be adapted to the required format before being displayed.

Function: Value function

Object	Function	Name	Type	DPT	Flag
	Value	1 byte object (DPT 6.010)	1 byte	6.010	C, W, T

Description 1 byte object to transmit and receive counter values. The received value can be adapted to the required format before being displayed.

Function: Limit value function

Object	Function	Name	Type	DPT	Flag
	Value	Object top limit value	1 bit	1.001	C, T

Description 1 bit object to transmit a limit value telegram, if the corresponding value object exceeds or undershoots the defined limit value.

Function: Limit value function

Object	Function	Name	Type	DPT	Flag
	Value	Object bottom limit value	1 bit	1.001	C, T

Description 1 bit object to transmit a limit value telegram, if the corresponding value object exceeds or undershoots the defined limit value.

Function: Date display function

Object	Function	Name	Type	DPT	Flag
	Date	Date object	3 byte	11.001	C, S

Description 3 byte object to display date information in a display element.

Function: Date display function

Object	Function	Name	Type	DPT	Flag
	Time	Time object	3 byte	10.001	C, S

Description 3 byte object to display time information.

Function: Text display function

Object	Function	Name	Type	DPT	Flag
	ASCII text	ASCII text object	14 b- yte	16.001... 16.002	C, S

Description 14 byte object to display text information.

Function: Access check function

Object	Function	Name	Type	DPT	Flag
	Access check	Access object	4 byte	15.000	C, S

Description 4 byte object to display the code number or individual parts of the status byte within an access check.

Function: Restraint function

Object	Function	Name	Type	DPT	Flag
	Restraint	Switching object	1 bit	1.001	C, W, T

Description 1 bit object for transmitting and receiving switching telegrams, which are used in conjunction with a higher level 2 bit restraint object.

Function: Restraint function

Object	Function	Name	Type	DPT	Flag
	Restraint	Restraint object	2 bit	2.001... 2.002	C, W, T

Description 2 bit object for transmitting and receiving higher-level restraint control information.

Function: Operating mode display function

Object	Function	Name	Type	DPT	Flag
	Operating mode switch	Operating mode Connex	1 byte	20.102	C, W, T

Description 1 byte object to display or switch the operating mode of a room temperature controller.

Function: Operating mode display function

Object	Function	Name	Type	DPT	Flag
	Operating mode switch	Frost/ heat protection	1 bit	1.001	C, W, T

Description 1 bit object to display or switch the operating mode of a room temperature controller.

Function: Operating mode display function

Object	Function	Name	Type	DPT	Flag
	Operating mode switch	Comfort-mode	1 bit	1.001	C, W, T

Description 1 bit object to display or switch the operating mode of a room temperature controller.

Function: Operating mode display function

Object	Function	Name	Type	DPT	Flag
	Operating mode switch	Night reduction	1 bit	1.001	C, W, T

Description 1 bit object to display or switch the operating mode of a room temperature controller.

Function: Operating mode display function

Object	Function	Name	Type	DPT	Flag
	Operating mode switch	Standby	1 bit	1.001	C, W, T

Description 1 bit object to display or switch the operating mode of a room temperature controller.

Function: Display function for collective feedback

Object	Function	Name	Type	DPT	Flag
	Collective feedback	Collective feedback	4 byte	27.001	C, S

Description 4 byte object to evaluate and display the switching state of a specific switching output of an actuator supporting collective feedback. The switching output to be evaluated in the collective feedback telegram is configured in the plug-in.

Function: Display function for dimmer actuator load type

Object	Function	Name	Type	DPT	Flag
	Dimmer actuator load type	Dimmer actuator load type	1 byte	20.xxx	C, S

Description 1 byte object to display the connected load type of a dimmer actuator channel.

Objects for status elements in the status line

Function: Display function for status elements

Object	Function	Name	Type	DPT	Flag
	Event display	Switching object	1 bit	1.001	C, W, T

Description 1 bit object to display information in the status line.

Objects for the fault message function

Function: Fault message

Object	Function	Name	Type	DPT	Flag
	Fault message	Acknowledgement object	1 bit	1.001	C, T

Description 1 bit object to confirm a received fault message.

Function: Fault message

Object	Function	Name	Type	DPT	Flag
<input type="checkbox"/> ←	Fault message	Fault signal object	1 bit	1.001	C, S

Description 1 bit object to receive a fault message.

Function: Fault message

Object	Function	Name	Type	DPT	Flag
<input type="checkbox"/> ←	Fault message	Acknowledgement reception object	1 bit	1.001	C, S

Description 1 bit object via which acknowledgements of other devices can be received.

Function: Fault message

Object	Function	Name	Type	DPT	Flag
<input type="checkbox"/> ←	Fault message	ASCII text object	14 b- yte	16.001... 16.002	C, S

Description 14 byte object to display a variable message text with a fault message activated.

Objects for the timers

Function: Timer

Object	Function	Name	Type	DPT	Flag
<input type="checkbox"/> ←	Timer	Start object	1 bit	1.001	C, T

Description 1 bit object which forwards the logical switching state of the timer output.

Function: Timer

Object	Function	Name	Type	DPT	Flag
<input type="checkbox"/> ←	Timer	Input object	1 bit	1.001	C, S

Description 1 bit object, whose value is forwarded to the output object of the timer, depending on the value of the appropriate blocking object, the set filter function and the defined delays.

Function: Timer

Object	Function	Name	Type	DPT	Flag
	Timer	Blocking object	1 bit	1.001	C, S

Description 1 bit object which specifies whether the value of the corresponding input object is forwarded to the output object. The behaviour of the blocking object can be set.

Objects for logic gate

Function: Logic gate

Object	Function	Name	Type	DPT	Flag
	Logic gate	Blocking object	1 bit	1.001	C, S

Description 1 bit object which specifies whether the value of the output object of the logic gate can be transmitted.

Function: Logic gate

Object	Function	Name	Type	DPT	Flag
	Logic gate	Input object	1 bit	1.001	C, S

Description 1 bit objects, which can be logically linked to each other. Each input object of a logic gate can be processed either normally or inverted.

Function: Logic gate

Object	Function	Name	Type	DPT	Flag
	Logic gate	Start object	1 bit	1.001	C, W, T, R

Description 1 bit object, which outputs the result of the logical link. The type of link (AND, OR, EXCLUSIVE OR, AND with return), the behaviour (normal or inverted) and the transmit criterion (transmit on any input event or send on changing the output) can be set.

Objects for multiplexers

Function: Multiplexer

Object	Function	Name	Type	DPT	Flag
	Multiplexer	Blocking object	1 bit	1.001	C, S

Description 1 bit object which specifies whether the value of the active output object of the multiplexer can be transmitted.

Function: Multiplexer

Object	Function	Name	Type	DPT	Flag
	Multiplexer	Control object ...	1 bit	1.001	C, S

Description 1 bit object which specifies to which output object the value of the corresponding input object is forwarded.

Function: Multiplexer

Object	Function	Name	Type	DPT	Flag
	Multiplexer	Control object ...	1 bit	1.001	C, S

Description 1 bit object which specifies to which output object the value of the corresponding input object is forwarded.
Two control objects may be visible, depending on the configured function (1 to 2 multiplexers or 1 to 4 multiplexers).

Function: Multiplexer

Object	Function	Name	Type	DPT	Flag
	Multiplexer	Input object	1 bit	1.001... 1.008	C, S
			4 bit	3.007 5.001...	
			1 byte	5.004 5.010	
			2 byte	6.010 7.001	
			4 byte	8.001 9.001... 9.021	
				12.001 13.001 14.000... 14.079	

Description Object with adjustable type, who value is forwarded to one of two or four output objects according to one or control objects.

Function: Multiplexer

Object	Function	Name	Type	DPT	Flag
□←	Multiplexer	Start object	1 bit	1.001... 1.008	C, T
			4 bit	3.007 5.001...	
			1 byte	5.004 5.010	
			2 byte	6.010 7.001	
			4 byte	8.001 9.001... 9.021 12.001 13.001 14.000... 14.079	

Description One of two or one of four output objects receiving the value of the input object.

Objects for datalogger

Function: Datalogger

Object	Function	Name	Type	DPT	Flag
□←	Datalogger channel	<Name is dynamic depending on the set data format.>	1 bit	1.001... 1.008	C, W, T
			4 bit	3.007 5.001...	
			1 byte	5.004 5.010	
			2 byte	6.010 7.001	
			4 byte	8.001 9.001... 9.021 12.001 13.001 14.000... 14.079	

Description Object with settable type, whose value is recorded by the panel at settable times and which can be displayed in a display element as a datalogger channel as a diagram on the screen.

Objects for presence simulation

Function: Presence simulation

Object	Function	Name	Type	DPT	Flag
	Status	Play active	1 bit	1.001	C, T

Description 1 bit object, which displays that a presence simulation is being played.
 0 = Presence simulation not being played / 1 = Presence simulation being played.

Function: Presence simulation

Object	Function	Name	Type	DPT	Flag
	Status	Recording active	1 bit	1.001	C, T

Description 1 bit object, which displays that a presence simulation is being recorded.
 0 = Presence simulation not being recorded / 1 = Presence simulation being recorded.

Function: Presence simulation

Object	Function	Name	Type	DPT	Flag
	Presence simulation	Start/stop playing	1 bit	1.001	C, S

Description 1 bit object, with which the playback of a presence situation can be started and stopped.
 0 = Stop presence simulation / 1 = Start presence simulation.

Function: Presence simulation

Object	Function	Name	Type	DPT	Flag
	Recording object	<Name is dynamic depending on the set data format.>	1 bit 1 byte	1.001 5.001... 5.010 6.001	C, W, T

Description Object with adjustable type (1 bit or 1 byte), whose received telegram values can be saved by time by the panel during a recording. The recorded telegrams can later be transmitted when playing back on the bus.

Object for e-mail mailboxes

Function: e-mail

Object	Function	Name	Type	DPT	Flag
	e-mail	Mailbox 1...5: new e-mail	1 bit	1.001	C, T

Description 1 bit object to signal whether there is a new, unread e-mail in one of up to five e-mail mailboxes. Each mailbox has its own object.
0 = No new e-mail available / 1 = New e-mail available.

Function: e-mail

Object	Function	Name	Type	DPT	Flag
	e-mail	Send e-mail	1 bit	1.001	C, S

Description 1 bit object, with which an e-mail predefined in the ETS can be sent.
The telegram polarity can be configured.

Objects for signalling system

Function: Signalling system

Object	Function	Name	Type	DPT	Flag
	Signalling system input	Internally armed, external skin monitoring	1 bit	1.001	C, S

Description 1 bit object to arm and unarm the external skin monitoring (internally armed).
0 = Unarm / 1 = Arm

Function: Signalling system

Object	Function	Name	Type	DPT	Flag
	Signalling system input	Externally armed, internal and external skin monitoring	1 bit	1.001	C, S

Description 1 bit object to arm and unarm the internal and external skin monitoring (externally armed).
0 = Unarm / 1 = Arm

Function: Signalling system

Object	Function	Name	Type	DPT	Flag
	Signalling system input	Sabotage	1 bit	1.001	C, S

Description 1 bit object as a sabotage of the signalling system. The sabotage detector can be connected to this object.
0 = No sabotage, detector inactive / 1 = Sabotage, detector active

Function: Signalling system

Object	Function	Name	Type	DPT	Flag
	Signalling system output	Ready to arm, internal	1 bit	1.001	C, T

Description 1 bit object to signal that the signalling system is internally ready to arm. The system is only internally ready to arm when none of the detectors allocated to the external skin is active and there is no fault.
0 = Not ready to arm / 1 = Ready to arm

Function: Signalling system

Object	Function	Name	Type	DPT	Flag
	Signalling system output	Ready to arm, external	1 bit	1.001	C, T

Description 1 bit object to signal that the signalling system is externally ready to arm. The system is only externally ready to arm when none of the detectors allocated to the internal skin and the external skin is active and there is no fault.
0 = Not ready for arming / 1 = Ready for arming

Function: Signalling system

Object	Function	Name	Type	DPT	Flag
	Signalling system output	Alarm	1 bit	1.001	C, T

Description 1 bit object to signal a break-in or sabotage alarm.
0 = No alarm / 1 = Alarm

Function: Signalling system

Object	Function	Name	Type	DPT	Flag
	Signalling system output	Arming message, internal	1 bit	1.001	C, T

Description 1 bit object for static signalling that the signalling system has successfully armed internally, i.e. the external skin monitoring is active.
0 = External skin monitoring not armed / 1 = External skin monitoring armed

Function: Signalling system

Object	Function	Name	Type	DPT	Flag
	Signalling system output	Arming message, external	1 bit	1.001	C, T

Description 1 bit object for static signalling that the signalling system has successfully armed externally, i.e. the internal and external skin monitoring is active.
 0 = Internal/external skin monitoring not armed / 1 = Internal/external skin monitoring armed

Function: Signalling system

Object	Function	Name	Type	DPT	Flag
	Signalling system output	Optical signal encoder	1 bit	1.001	C, T

Description 1 bit object to control an optical alarm, e.g. flashlight. If there is an alarm (only with external arming), signalling is carried out via this alarm output. In addition, with external arming, an acknowledgement can be given by the optical alarm encoder (parameter-dependent).
 0 = No alarm, flashlight off / 1 = Alarm, flashlight on

Function: Signalling system

Object	Function	Name	Type	DPT	Flag
	Signalling system output	Internal siren	1 bit	1.001	C, T

Description 1 bit object to control an acoustic alarm, e.g. internal siren. If there is an alarm (internal or external arming), signalling is carried out via this alarm output. If there is an alarm, control of this alarm output is restricted to a certain period of time. This time can be parameterised in the ETS.
 0 = No alarm, internal siren off / 1 = Alarm, internal siren on

Function: Signalling system

Object	Function	Name	Type	DPT	Flag
	Signalling system output	Arming acknowledgement	1 bit	1.001	C, T

Description 1 bit object to signal that the signalling system was armed internally or externally. The object is dynamic, meaning that it is only "1" for the arming acknowledgment period specified in the ETS. In the unarmed state or if the arming acknowledgment time has elapsed, the object value is "0".
 For example, appropriate pulse blocking elements can be connected to this signal output.

Function: Signalling system

Object	Function	Name	Type	DPT	Flag
	Signalling system output	Unarming acknowledgement	1 bit	1.001	C, T

Description 1 bit object to signal that the signalling system was unarmed internally or externally. The object is dynamic, meaning that it is only "1" for the unarming acknowledgment period specified in the ETS. In the armed state or if the unarming acknowledgment time has elapsed, the object value is "0". For example, appropriate pulse blocking elements can be connected to this signal output.

Function: Signalling system

Object	Function	Name	Type	DPT	Flag
	Signalling system output	Fault	1 bit	1.001	C, T

Description 1 bit object for signalling a fault within the signalling system (missing detector, active sabotage input).
0 = No fault / 1 = Fault.

Function: Signalling system

Object	Function	Name	Type	DPT	Flag
	Signalling system output	Alarm detector text	14 b- yte	16.001	C, T

Description 14 byte object to transfer a 14 character detector text to the bus. If there is an alarm, the signalling system sends the signal text of the detector triggering the alarm to the bus via this object. The detector text can be configured separately for each detector in the ETS.

Function: Signalling system

Object	Function	Name	Type	DPT	Flag
	Signalling system output	Fault detector text	14 b- yte	16.001	C, T

Description 14 byte object to transfer a 14 character detector text to the bus. If there is an alarm, the signalling system sends the signal text of the detector which caused the fault (missing detector) to the bus via this object. The detector text can be configured separately for each detector in the ETS.

Function: Signalling system

Object	Function	Name	Type	DPT	Flag
	Signalling system output	Prealarm signalling, internal	1 bit	1.001	C, T

Description 1 bit object to signal an elapsing prealarm with internal arming. In the case of previously detected break-in of sabotage alarm, this signal output is "1" for the length of the alarm delay time configured in the ETS. Otherwise the object value is "0".

Function: Signalling system

Object	Function	Name	Type	DPT	Flag
	Signalling system output	Prealarm signalling, external	1 bit	1.001	C, T

Description 1 bit object to signal an elapsing prealarm with external arming. In the case of previously detected break-in of sabotage alarm, this signal output is "1" for the length of the alarm delay time configured in the ETS. Otherwise the object value is "0".

Function: Signalling system

Object	Function	Name	Type	DPT	Flag
	Signalling system input	Detector	1 bit	1.001	C, W, T

Description 1 bit object as detector input. There is exactly one detector object for each detector input for the internal and external skin security areas created in the ETS. The group address of exactly one KNX/EIB detector is linked to this object. The telegram polarity of the detector telegram can be configured. The signalling system cyclically tests the function of a KNX/EIB detector, by the system transmitting a value read telegram to the bus via the detector object. The KNX/EIB detector (e.g. the channel of a button interface of a binary input) must answer the read telegram of the signalling system with a value answer telegram. For this, the "Read" flag must be set on the communication object of the KNX/EIB detector.

Object for light scene function

Function: Light scene function

Object	Function	Name	Type	DPT	Flag
	Light scenes	Extension object	1 byte	18.001	C, S

Description 1 byte object for opening or saving light scenes.

Function: Light scene function

Object	Function	Name	Type	DPT	Flag
	Light scene group	Light scene object	1 bit	1.001	C, W, T
				5.001...	
			1 byte	5.004	

Description 1 bit object or 1 byte object for controlling the actuator group contained in a light scene.

4.2.4 Functional description

Introduction

The panel allows the display and control of building functions from a central location. To aid display, there is a freely-programmable, colour TFT display with a resolution of 320x240 pixels. It is operated via the touchscreen.

The panel allows bidirectional communication with the various data formats via EIB/KNX communication objects. Both basic functions, such as switching, dimming and blinds, and also complex functions such as value encoders, date, limit values, etc., can be processed. The user interface is freely configurable, i.e. the display texts should be matched individually. It is possible to include wallpapers and icons in the bitmap (bmp) and Joint Photographic Experts Group (jpg) formats.

The panel is configured and commissioned using an ETS plug-in. During the configuration of the communications interfaces with other KNX/EIB devices, the ETS plug-in dynamically creates the required communication objects to all the functions. Therefore, there is no fixed allocation between individual functions and the numbers of the communication objects. Within the ETS, centralised objects and all the allocated group addresses are displayed for each projected data format, so that, if need be, filter tables can be generated by the KNX/EIB area or line couplers.

4.2.4.1 Basic settings during project planning

Some of the settings made in the ETS plug-in relate to the whole device. This means they may also influence a larger number of other settings. For example, the following general settings should be made...

- At the start of project planning, for example, the installation position of the panel, the bus communication behaviour, the behaviour of the LCD background lighting and the date and time functionality specified.
- In addition, for first commissioning, the settings relating to download behaviour (behaviour after a programming operation by the ETS or the plug-in) are important.
- There are eight different colour scheme available to design the individual screen pages and the elements therein. The colour schemes can be adapted individually.
- The ETS plug-in has a large volume of data to manage, particularly when images are used. This data can either be saved in the ETS database or in separate files. You can configure image storage in the panel options.

The settings relevant to the whole device are summarised within the first parameter group of the ETS plug-in (top parameter node). This parameter group is divided into the subgroups "General", "LCD lighting", "Date / time" and "Download behaviour".

Start the ETS plug-in by opening the parameter view of the appropriate panel in the ETS project view.

4.2.4.1.1 General parameters

Installation position

The panel can be used both horizontally, in landscape format, and vertically, in portrait format. When starting project planning you must accordingly select the installation position of the display (portrait corresponds to 240 x 320 pixels and landscape to 320 x 240).

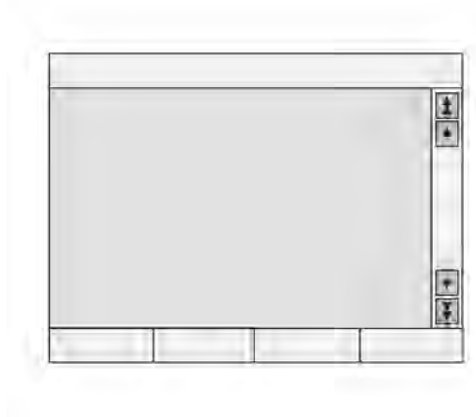

Figure 6: Installation position in landscape format (horizontal)



Figure 7: Installation position in portrait format (vertical)

The selected installation position and the available monitor dimensions then apply to the entire project planning. If the installation position is reconfigured, then all the other panel settings in the ETS plug-in are lost (deletion of all the pages and all additional settings). For this reason, the plug-in generates a warning when switching parameters. Only after the warning has been confirmed do the plug-in change the installation position.

Monitor display

Colour schemes:

To allow easy adjustment of the display element visualisation and, at the same time, an easy to read display, the ETS plug-in provides eight different colour schemes. The first colour scheme is fixed. The other seven colour schemes can be changed as required. The "System colour scheme" parameter in the "General" parameter group specifies the colour scheme for all the system pages and defines the presetting for each screen page newly created by the project planning. This higher-level colour scheme is termed "System" in the parameters of each screen page (see chapter 4.2.4.1.5. Colour schemes).

Scroll bar:

The individual screen pages and the display elements within a screen page can be arranged one beneath the other in a specific logic sequence. A scroll bar can be displayed on the right edge of the screen, using which it is possible to switch between the elements in a forwards and backwards direction.

- The two double arrows open the previous or the next screen page. You can specify which pages are jumped to with this navigation in the ETS plug-in.
- Within the current screen pages, the two single arrows activate the next or previous display element, assuming that multiple display elements can be selected.

If there is no previous or next element defined in the project planning, the appropriate arrow is automatically deactivated. The "Scroll bar" parameter in the "General" parameter group in the top parameter node specifies the basic properties of the scroll bar...

- "Always show" setting: the scrollbar can be seen on every screen page. It takes up space, even if no linked pages are planned.
- "Always hide" setting: the scrollbar cannot be seen on any screen page. In this case, it is not possible to navigate between the screen pages using the scroll bar.
- "Automatic" setting: the scroll bar is only shown when there is a previous or next page available, meaning that page navigation is required. Otherwise the scroll bar is hidden on a page created by the project planner.

i With the "Always show" and "Automatic" settings, the scroll bar can also be seen on some system pages.

Character set and keyboard layout:

In order to display texts in various languages on the screen, and, if necessary, input them, you need to set the character set (codepage) of the device and the assignment of the on-screen keyboard.

The "System character set" parameter in the "General" parameter group in the top parameter node specifies the character set used for all the system pages. In addition, each page created by the project planner can be configured separately with its own "character set". This configuration is then possible in each parameter node of a page. There the system character set ("System" setting) can also be used as a default setting, if, for example, the same character set is always used. However, it is also possible to use different character sets for pages.

Start page

The device initialises after switching on the mains power supply or after a programming operation. During this time the Start screen is shown on the display. After initialisation, the panel automatically displays the screen page specified using the "Start page" parameter in the "General" parameter group in the top parameter node. At this point, any page created by the project planner can be selected. Page 1 is the default Start page.

If, during operation, the panel is not operated for a specific period of time, there may be an automatic jump back to the Start page. For this, the "Automatically to Start page" parameter must be set to a return time.

Acoustic signal

The table can signal the reception of defined fault messages with an integrated piezo buzzer. Such a signal is automatically terminated after a set time (parameter "Length of acoustic signal").

In addition, the parameter "External object for acoustic signal" also allows the option of using the piezo buzzer independently of the fault message function. If the signal tone is switched on via the external object, then it must also be switched off via this object. All the other acoustic signals are suppressed during this time.

In this case, the piezo buzzer is not automatically switched off after the period of the "Length of

acoustic signal" parameter, meaning that there is a continuous tone, when controlled via the external object (Object = 1: Buzzer ON / Object = 0: Buzzer OFF).

Bus communication

The following general settings influence the communication between the panel and other devices...

Telegram acknowledge:

A display element usually shows the current value of a communication object (e.g. ON or OFF). If the communication object does not possess a valid value, then the display element will just show a line of dashes "-----" rather than the value in the display element.

Even if the panel does not receive an acknowledgement of another KNX/EIB bus subscriber - for example due to the operation of a display element - it displays this undefined status. The "Telegram acknowledge" parameter allows you to use the "Not required for status display" parameter to show a self-sent value, even without a valid acknowledgement. Caution: this setting may cause the panel to display values which deviate from the real status in the KNX/EIB system. Such cases may occur, for example, if a device has a longer initialisation phase and cannot react to telegrams during this period.

With the setting "Required for status display", an external acknowledgement of a sent telegram is always required until the panel displays a valid value in the display element.

Delays:

Directly after initialisation, the panel is unable to display the system status correctly. Only when a valid value has been transmitted or received does the display element change.

To be able display valid values as quickly as possible after a restart, the panel has the option of transmitting read requests to selected group addresses. Here it is important to note that different devices required different lengths of time for initialisation, for example after the return of bus voltage. The read requests with the subsequent response telegrams may lead to an unexpectedly bus load. For this reason, you have the option of configuring the waiting time up to the first read request using the "Status poll delay after start" parameter. In addition, the "Delay between status polls" parameter can be used to adjust the bus load resulting from a status poll, i. e. the time between two read telegrams.

Opening or closing light scenes also leads to a temporarily increased bus load. Here, the panel takes the parameter "Delay between light scene outputs" into account and increases the time between the individual light scene telegrams.

Limit values:

With display elements for counters or floating values, one top and one bottom limit value can be defined. If this monitoring is active, then the ETS plug-in displays the appropriate switching objects. In normal operation, these limit value objects only send a telegram when the value of display element exceeds or undershoots a configured limit value threshold. Because, after panel initialisation, the display elements do not usually possess a valid value, the "Transmit limit values after initialisation" parameter allows telegram transmission of the limit value objects, as soon as the appropriate display element has received a valid value

Password for PC Client software

The PC Client software is used by the end user to operate the panel from a PC. All the screen elements of the panel are displayed on the PC monitor and can be operated on the panel as if being done directly (remote communication). The user can also use the PC Client software to load various configuration data (IP settings, e-mail mailboxes, RSS newsfeeds) into the panel without requiring access to the ETS.

The communication connection between the PC Client software and the panel is protected by a password. With the PC Client software, the password is set in the device connection data (see chapter 4.3.1. Introduction, installation and program start). On the panel side, the password is configured in the ETS plug-in. The "Password for PC Client software" parameter in the top parameter node in the "General" parameter group allows the input of a password of maximum

16 characters. The box can also be left empty meaning that communication between the PC Client software and the panel takes place without password protection. The password entered in the PC Client software and the panel must be identical. The password is encrypted in the communication connection, meaning that it is safe from sabotage.

4.2.4.1.2 LCD lighting

Depending on the required installation location and the light characteristics, it may be desirable that the display is illuminated either permanently or temporarily. The parameter "LCD lighting" in the "LCD lighting" parameter group in the top parameter node makes three options available for this...

- In the "Continuous operation" setting, the background lighting is switched on at maximum brightness. It cannot be switched, either via the device or the bus.
- In the "On actuation" setting, the background lighting is adjusted to the set basic brightness value when idle. This means that the background lighting may even be switched off. As soon as the device is operated via the touch screen, the lighting returns to maximum brightness. After the set "LCD lighting length" time, the backlighting returns to the set basic level of brightness.
- In the "On actuation or switching object" setting, the lighting is adjusted to the set basic brightness value when idle. When the touch screen is actuated or when a switching value is received via the "Lighting object" communication object, the lighting temporarily switches to maximum brightness for the configured "LCD lighting length". In addition, the backlighting can also be switched off at any time via the object. The telegram polarity of the lighting object can be configured in the ETS.

- i** The basic level of brightness can be configured in the ETS plug-in. The settings "OFF", "Dark" and "Light" are available.
When the basic level of brightness is set to "Light", the display is always at maximum brightness for all the settings of the "LCD lighting" parameter.

4.2.4.1.3 Date and time

The panel possesses an integrated real time clock (RTC). This clock is used both to display the current time and date but also to control the timer switch channels or the presence simulation. The time and date functionality of the panel is configured using the parameters in the "Date / Time" parameter group in the top parameter node of the ETS plug-in.

The time and date display can be set using the "Display format ..." parameters. For the date, there are the options of specifying the year with two or four digits and selecting the sequence day-month-year or month-day-year.

In most cases, within a KNX/EIB system, a device is sufficient which transmits the current time and date at regular intervals, so that all the other devices can synchronise themselves as required. If possible a device should be used which has high accuracy through the reception of the DCF 77 time signal.

The integrated real time clock of the panel can be set by such an external clock. The parameter "Comparison with external clock" specifies whether the time and / or date are to be synchronised. Then, if necessary, the two communication objects "Master date" and "Master time" are created. In addition, the panel can use the 1 bit communication object "Request date / time", in order to synchronise itself. This communication object transmits - if enabled in the parameters - a request telegram after each device initialisation and then regularly once a day at 4:00 a.m. The telegram polarity can be configured in the ETS plug-in.

If there is no opportunity for external bus synchronisation, then the panel can transmit the date and time to the bus once a day, once an hour or once per minute (depending on the parameters) into order to synchronise other KNX/EIB devices. The values are transmitted using the objects "Date object" and "Time object". In this case, the transmission behaviour is defined by the "Send date" and "Send time" parameters.

A distinction should be made between the following settings...

- "Do not transmit" setting: the panel does not automatically transmit the date and/or time to the bus. In such cases, there is no synchronisation of external bus subscribers.
- "Transmit cyclically" setting: the panel transmits the date and/or time to the bus cyclically. The parameters "Cycle time for date transmission" and "Cycle time for time transmission" define the regularity of transmission.
- "Transmit on request" setting: in this configuration, there is an additional 1 bit communication object with the name "Request date / time through external device" available. When the panel receives a switching telegram from another KNX/EIB bus subscriber via this object, it evaluates the telegram as a request and transmits the current date and its own time to the bus as a response. The telegram polarity of the external data and time request can be configured in the ETS..
- "Transmit cyclically and on request" setting: this setting is a combination of the two single configurations described above.

i It is possible to use the panel request (parameters "Request date / time" synchronisation through "MasterDate" and "MasterTime" objects) and, in 'parallel' the external request of other bus subscribers (parameter "Send date / time = On request..."). The functions are not mutually incompatible.

For example, the panel can receive the date and time from a KNX/EIB master clock and also synchronise other external bus subscribers.

i The "Date object" and "Time object" objects can be read out independently of cyclical transmission or any time by a poll (set "Read" flag).

The data point types "Date" (11,001) and "Time" (10,001) do not contain any information about whether summer time or normal time (winter time) is active. For this reason, the "Automatic time setting" parameter can specify in which form the panel carries out the change from summer to winter time and vice-versa.

A distinction is made between the following settings...

- The "According to European standard" setting means that the panel automatically sets the time one hour ahead from the last Sunday in March to the last Sunday in October, i.e. switches to summer time.
- The setting "As switching object" activates the "Automatic time setting" communication object. When this object has the value "1", the panel uses summer time (+1 hr.). When it has the value "0", the panel uses the unchanged normal time. During initialisation, the "Automatic time setting" objects transmits a single read request to the bus (status poll object flag = yes).
- The effect of the "No" setting is that the panel does not automatically switch from summer to winter time, for example, because a higher-level clock has already transmitted appropriately corrected date and time information.

4.2.4.1.4 Download behaviour

After commissioning, the operator can make various settings directly on the panel while the system is running. These include the names and settings of light scenes, switching times and limit values.

During first commissioning of a device with new project planning data, these parts must be overwritten. For this, set the parameters "Overwrite light scene names, delete values", "Overwrite all timer switch switching times" and "Overwrite limit values" to "Yes". These parameters are located in the "Download behaviour" parameter group of the ETS plug-in. After first download, the parameters can be reset to "No" to maintain any changes made by the user in subsequent programming operations.

Exceptions: with later project planning changes, the parameters must be set to "Yes" after changes, so that the changes are transferred correctly to the device memory of the panel.

- Light scenes added or deleted
- Light scene groups added or deleted
- Sequence of light scenes changed
- Type of light scene groups (communication objects) changed
- Timer switch channels added or deleted
- Sequence of timer switch channels changed
- Function of the timer switch channels (type of communication objects) changed
- Value display (EIS type, data point type) of a monitored value changed
- Value monitoring activated or deactivated
- Top or bottom limit value activated or deactivated
- Numeric value of a limit value changed.

- i** The parameter "Overwrite all switching times of the timer switch" should be set to "Yes", if the switching times predefined in the ETS plug in should be reloaded into the panel after each programming operation.

4.2.4.1.5 Colour schemes

For each newly created screen page, one of eight colour schemes can be selected in the project planning (see chapter 4.2.4.1.1. General parameters). Open the dialog using the plug-in menu "Setting - Colour scheme...", and then define the colours for the individual text and graphic elements .

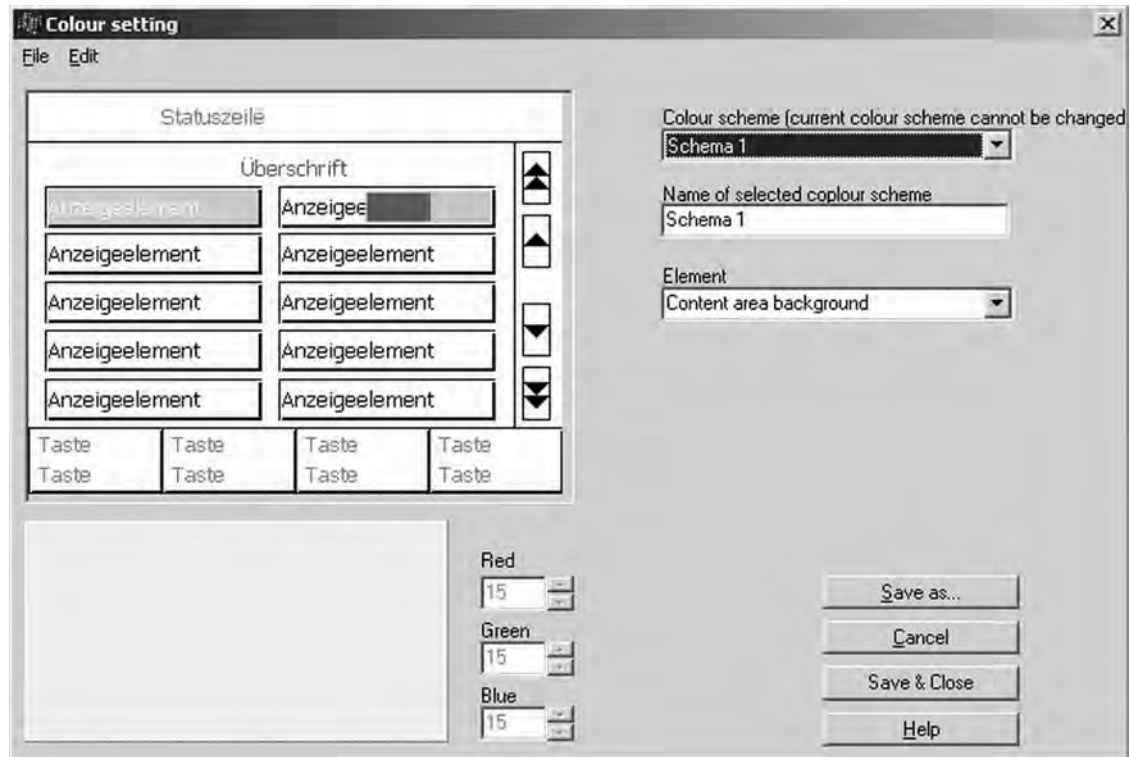

Figure 8: Dialog for setting the colour schemes

Colour scheme one is fixed. On the one hand, it is used as a basis for the development of your own colour settings, on the other it also presents the option of returning to an extremely legible scheme, as required.

To create your own colour scheme, we recommend modifying an existing scheme. To create multiple matching schemes, you can copy the current scheme to the clipboard and reinsert it.

To be able to return to the same, self-defined colour scheme with various devices, you can export the currently selected colour scheme to a file.

- i** The colour display in the ETS plug-in (PC monitor display) may look different than on the device. Therefore, we recommend comparing the colours on the PC monitor with the colours shown on the device.

4.2.4.1.6 Image list

The panel can show images as a wallpaper to the information area, as an element in the status line and as a display element. These images are saved in a project image list in the ETS plug-in, so that they are easily available for multiple use. The "Image list" dialog can be opened in the plug-in via the menu "Settings - Image list...".

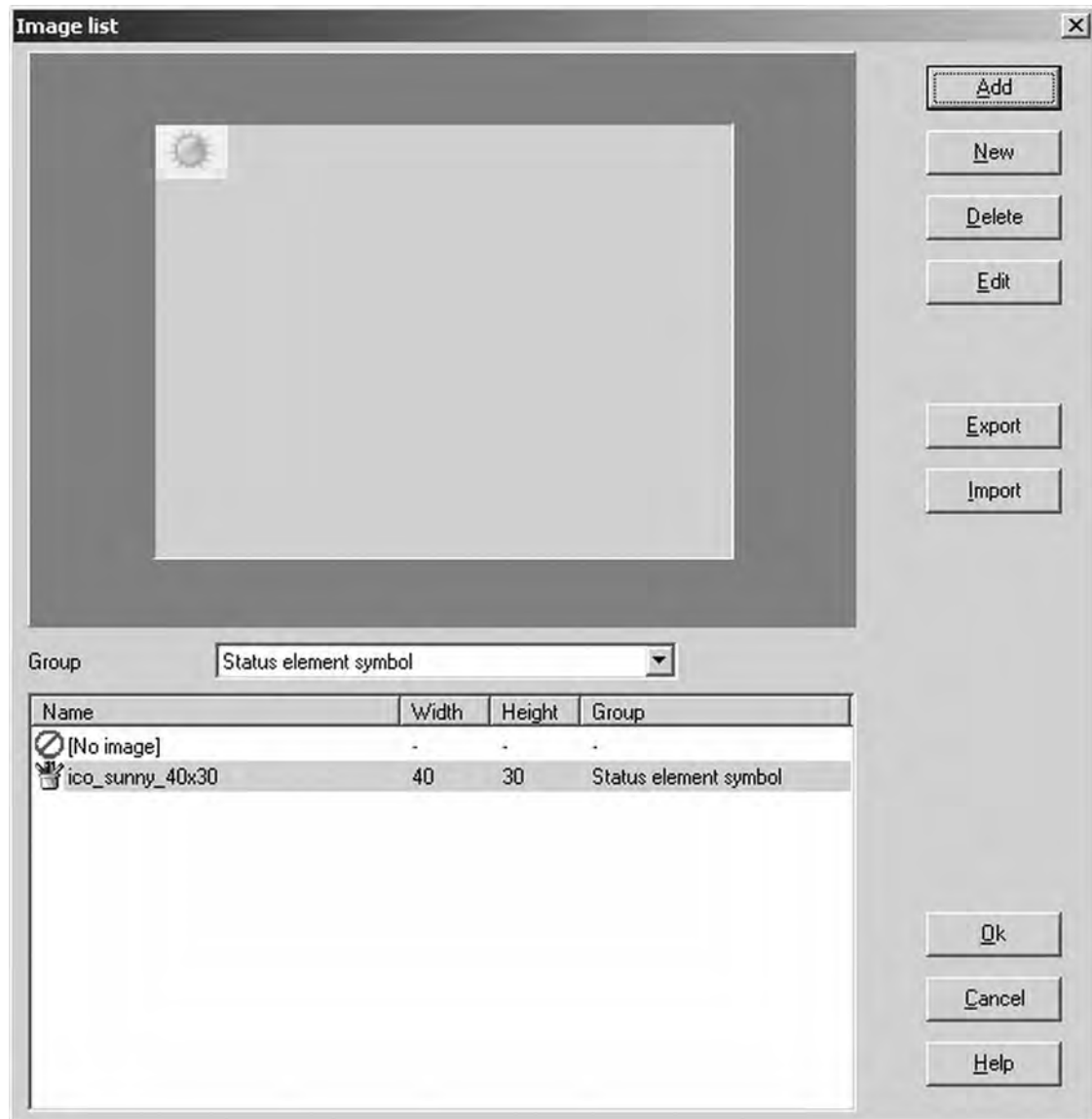

Figure 9: Image list dialog

In the preview area on the left side of the dialog, that image is displayed which is selected in the image list below. For better recognition, this list can be structured in three groups: Wallpapers, Display elements and Status elements.

The "Add" button opens the dialog in which an existing image can be selected. This image is then added to one of the image groups.

The "New" button opens a dialog to create a new image, which can then be generated using image processing software. This newly-created must then be added to the image list.

The "Export" and "Import" buttons allow the backup of image lists into separate files, in order to use them in different devices, for example.

Automatic image scaling:

On importing new images into the image list, image lists, which are larger than the approved maximum sizes of 320 x 240 pixels (for landscape format) or 240 x 320 pixels (for landscape format), can be scaled down appropriately and saved in this maximum format. The page ratio is maintained during scaling (proportional scaling).

Image transparency:

On importing images, you can specify whether parts of the images are to be transparent in the panel display. For example, the transparency function is advisable for images in display elements in which the wallpaper should be seen at some points of the element (e.g. for level displays).

If image transparency is required, the checkbox "Image contains transparency" must be selected in the import dialog. In this case, the colour which is to be transparent is defined by the first pixel at the top left.

Import filter:

When importing images into the image list, you can switch the import filter on and off (dithering filter) using a checkbox in a separate import dialog.

Importing an image reduces the colour information so that it can later be shown on the panel display (display in maximum 4,096 colours). Switching the import filter on means that an illusion can be used to expand the colour-reduced images to a subjectively greater colour depth, meaning that there are no hard colour transitions on the panel display.

The import filter is activated by default. If necessary, it can be deactivated in the import dialog (deselect the "Import filter" checkbox).

- i In contrast to the rest of the project planning data, the image list requires quite a lot of memory. The time it takes to start the project planning software can be reduced considerably by saving images not to the ETS database but to a separate file. In the options of the ETS plug-in (menu "Setting -> Options -> Options"), you can specify how the image data is saved.

In the project planning window of the ETS plug-in, the parameter groups of pages, display elements and the status elements always access the "Image list" dialog when images are to be selected from the list and inserted in the device project planning.

- i If an image is to be displayed in a display element, the size of the visible area of the image is aligned to the set size of the display element. The size is defined in the parameter group of a display element. The Width x Height specification describes the usable interior of a display element without a frame.

4.2.4.1.7 Preview and resource monitor

The ETS plug-in allows, through the positionable status elements and display elements, the colour schemes and the images, a large variety of adaptations. A preview window can be opened from the "View" plug-in menu, allowing direct control of project planning.

In contrast to devices which are planned and programmed directly with the ETS, the ETS plug-in allows full control of communication objects and the allocation of the group addresses. The Resource Monitor, which can be opened via the "View" menu, offers an overview of the number of available communication objects and the group addresses. As the different communication object types require different amounts of space, creating and connecting an object automatically changes the quantity for all the other object types.

4.2.4.2 Screen pages

The panel is used for the central display of statuses and to control building functions.

For a structured display of these tasks, up to 50 freely-adjustable screen pages can be defined. Each page can display up to 16 display elements, to each of which up to four definable function keys can be allocated. The maximum total amount of display elements in the panel is limited to 400. This means that, for example, 50 pages each with 8 display elements or 25 pages each with 16 display elements can be created.

The display elements can variably modified in both size and position.

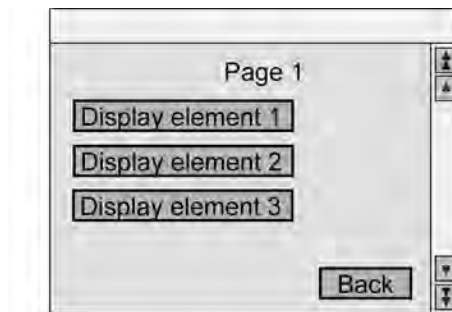

Figure 10: Screen page as an example for display elements

Permanently defined special pages are available for specific tasks. This include the following pages...

- Light scenes
- Timer switch
- Service page (with various subordinate pages)
- Fault messages
- Message list
- Signalling system
- Presence simulation
- On-screen keyboard
- On-screen numeric keypad

i Detailed descriptions of the individual special pages can be found in the following chapters of this documentation.

4.2.4.2.1 General page structure

Page areas

Each newly created page consists of four areas.

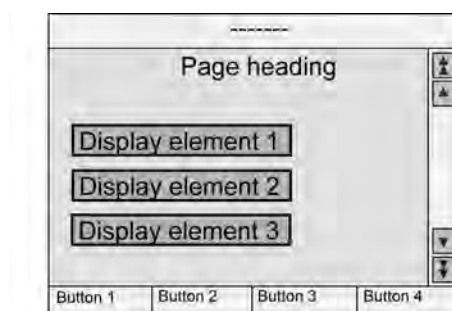

Figure 11: General page structure

The largest area is the **Content area**.

This is always available. Its dimensions depend on the other three areas, which are optional, and on the installation position of the device.

A **Status line** can be displayed at the top edge of the monitor.

If the status line is used, it covers the top section of the Content area. The status line is optional and can be enabled in the ETS plug-in for individual pages. The height of the status line is 30 pixels.

The **scroll bar** can be displayed at the right edge of the monitor.

If the scroll bar is used, it covers the right section of the Content area. The scroll bar is optional and can be enabled in the ETS plug-in globally in the panel or for individual pages. The width of the scroll bar is 30 pixels.

The four **function buttons** can be displayed at the bottom edge of the screen.

If the function buttons are displayed, they cover the bottom part of the Content area. The function buttons are optional and can be enabled depending on a display element in the ETS plug-in. The function buttons are 40 pixels high. The width of each of the four buttons depends on the installation position of the panel. The maximum widths of the monitor is divided by four.

Depending on the installation position of the device, the dimensions of the content area are...

- Maximum 320 x 240 pixels in landscape format
- Minimum 290 x 170 pixels in landscape format
- Maximum 240 x 320 pixels in portrait format.
- Minimum 190 x 290 pixels in portrait format.

The reference point (X = 0, Y = 0) for positioning the display elements is the top left corner of the display.

At first, a newly-created panel only contains one screen page. This page can be edited just like any other newly-created page. New pages can be added using the context menu (click the right mousebutton), if the parameter node "Pages" is highlighted in the tree structure of the ETS plug-in.

Page parameters

Each new screen page possesses a display element and the same setting options...

- Designation: This text is only displayed for identification purposes in the tree structure of the ETS plug-in.
- Heading: This text (max. 33 characters, the last characters may be covered by the scroll bar) can be displayed in the centre of the panel display as a heading. Optionally, the page designation can be applied automatically to the heading field. This automatic apply function can be deactivated in the Options dialog of the plug-in as necessary (menu "Settings -> Options -> Options").
If required, the page heading display on the panel can be switched off by setting the "Display heading" parameter to "No".

- Password level: The page can be assigned one of four password levels, or can be opened without a password. The passwords for the four levels are entered directly on the panel, on the service side. If an incorrect password is entered on opening a page, there is an automatic return to the page from where the action was taken.
- Wallpaper: Here you can select one of the images from the image list. If the status line, the scroll bar or the function buttons are displayed, they will cover parts of the wallpaper.
- Colour scheme: The presetting "System" for the colour scheme of a page means that the panel uses the system colour scheme for the page layout, as selected in the "General" parameter group in the top parameter node of the plug-in. Alternatively, different colour schemes can be used for each individual page. The user can replace the colour scheme of a page with another via the Service page of the panel.
- Character set: The presetting "System" for the character set of a page means that the panel uses the system character set to display text, as selected in the "General" parameter group in the top parameter node of the plug-in. Alternatively, different character sets can be used for each individual page.
- Display status line: For each page, you can set separately whether the status line is to be shown on the top edge. The status line is the same on every page. The appearance of and information in the status line are configured separately in the "Status line" parameter node in the ETS plug-in.
- Previous page, Next page: Multiple pages created by the project planner can be connected, meaning that it is possible to navigate between the pages using the scroll bar. The double arrows of the scroll bar then allow a switch between the linked pages. If, in the "General" parameter group in the top parameter node of the plug-in, the scroll bar is always hidden, the scroll bar function is not accessible on a page. However, the parameters "Previous page" and "Next page" are visible.

Open page via object

Each screen page of the panel (pages created by the project planner and, optionally, various system pages) can be opened via a 1 byte KNX/EIB communication object. If a page should be opened via the object, the parameter "Open page via object" in the "General" parameter group in the top parameter node of the ETS plug-in should be set to "Yes". In this case the object "Open page" becomes visible in the same parameter node.

As soon as the panel receives a telegram via this object, it jumps to the appropriate screen page and immediately shows it on the display. The page to which the panel jumps is directly defined by the received telegram value (see Table 1).

Screen page	Telegram value
User pages 1...50	1...50
Service page, main page	51
Service page, area 1	52
Service page, area 2	53
Service page, area 3	54
Service page, display cleaning	55
Service page, service address display	56

Service page, version	57
Service page, message list	58
Service page, history	59
Service page, IP overview	60
Signalling system, main page	61
Signalling system, detector list	62
Signalling system, event memory	63
Presence simulation, main page	64
Presence simulation, channel list	65
Timer switch, page 1	66
Timer switch, page 2	67
Light scenes, page 1	68
Light scenes, page 2	69
Light scenes, page 3	70
RSS feed menu	71
e-mail mailboxes	72

Table 1: telegram values for opening the screen pages

Various system pages (see Table 1) can also be optionally opened via the communication object. This is only possible when the parameter "System pages opened via object" is configured as "Yes" in the top parameter node "General". Otherwise, it is not possible to open the system pages. In the ETS plug-in, the telegram value numbers of the system pages, which can be jumped to via the object, are displayed in the name of the parameter node in square brackets.

- i** When a page is requested via the "Open page" object which does not exist or may not be opened, the panel will not react. The same applies to the reception of a telegram value which is not assigned to any page (0, 75...25).
- i** On jumping to a password-protect page, there is an automatic return jump after 30 s, if no valid password was entered in the interim. The "Return" button function jumps back to the last page displayed.

4.2.4.2.2 Display elements

Introduction

Display elements can be positioned anywhere within the available Content area. Their size are specified by the parameters "Width" and "Height". The display elements themselves are limited by a frame.

A display element is added to a page using the context menu (click the right mousebutton). The parameters of a display element are located in the parameter group of the element.

Each display element has a designation with which it is displayed in the tree structure of the ETS plug-in.

Illustration

A display element also possesses a text, which can be displayed on the panel display.

Depending on the chosen option, the text either agrees with the element designation in the ETS plug-in or it is specified by the project planner. It is also possible to specify no special display text.

The text can be positioned both horizontally and vertical in the area of the display element (X position and Y position). In particular in conjunction with wallpapers, it may be that the frame and / or the background of the display element should be hidden or made transparent, in contrast to the selected colour scheme.

A display element may also show a icon, in addition or as an alternative to the text display. This element icon is permanently allocated to the display element and cannot be changed during panel operation. The element icon is positioned independently of the position of the display text using separate parameters. An element icon is configured using the "Icon..." parameter in the "General" parameter group of the parameter node of a display element.

If a display element is only to have one display function without any operating function, it can be set as "Not selectable".

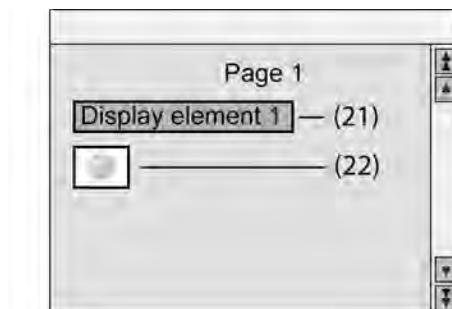

Figure 12: Types of display elements

(21) Display element with text display

(22) Display element with icon display (element icon)

i Text and icons can be combined with each other. In this case the text may overwrite the icon.

- i** In addition to an element icon (figure 12), a status icon can also be assigned to the display status values of the element (see following section "Display function"). It should be noted that, depending on the planned icon position, the element icons and status icons may overlap. In so doing, a status icon overwrites an element icon. A status icon also overwrites the display text of an element.
As the icons can also have transparent colours (see chapter 4.2.4.1.6. Image list), overlaps may also achieve interesting display effects (e.g. level displays, etc.).

Display function

The settings in the "Function" parameter group of a display element specify whether one or more communication objects belong to the display element and which information it can display in addition to its text or element icon. Depending on the configured function, text values or, alternatively, status icon can be displayed as the element status. The status text or icon display can be positioned anywhere in a horizontal direction (X position / user-defined or predefined) in the area of the display element. The vertical Y position of the status text display corresponds to the vertical text direction of the display element, the vertical Y position of the status icon display is always defined as centred.

The following display functions can be assigned to a display element...

Text display:

A display element with the "Text display" function does not contain any communication objects or any further settings.
Only the display text or the element icon is displayed, without any operating function, in the element.

Switching:

A display element with the "Switching" function possesses a 1 bit communication object. It can either display the status of this object as a display text or as an icon.

Dimming:

A display element with the "Dimming" function possesses either a 1 bit and 4 bit communication object or, alternatively, a 1 byte communication object. The element dimming state can either show a display text or an icon for the dimming switching state when using the 1 bit and 4 bit object. It can either display the dimming value of the 1 byte object as text or as a bar graph.
If the display element is also to be used as an operating element, it is necessary, to adjust the parameters in the display to make a distinction between switching (brief actuation) and dimming (long actuation).

Blind:

A display element with the function "Blind" possesses two 1 bit communication objects for long-time operation and short-time operation of a blind, roller shutter or awning (or similar structures). It can either display the value of the "Long-time operation" object as a display text or as an icon. When a short-time telegram is received, the position, e.g. of a blind or roller shutter drive, is not defined. In such a case, dashes "----" are displayed in the element as the status.
If the display element is also to be used as an operating element, it is necessary, to adjust the parameters in the display to make a distinction between lamella adjustment (brief actuation) and movement (long actuation).

Value:

A display element with the "Value" function possesses a communication object whose value

(1 byte, 2 byte, 4 byte) is set using the "Value display" parameter. Counter values with the data point types 5,010, 6,010, 7,001, 8,001, 12,001, 13,001, floating point values with the data point types 9,001 ... 9,021, 14,000 ... 14,079 or relative values with the data point types 5,001 ... 5,004 can be used. In the telegrams to the bus, a purely numeric value is transmitted without a unit.

The units of the standardised data point types may not correspond to the form required for the display. Therefore, there are various adjustment options available depending on the set type of "Value display"...

The numerical values can be converted with the two parameters "Offset" and "Reinforcement". This displayed value equals the received value multiplied by the reinforcement plus the offset. The parameter "Format" can be used to define the number of valid digits and the amount of decimal places. Additional decimal places are rounded off. The "Unit" parameter offers a range of standard units. Additional units can also be defined.

If the parameter "Limit value monitoring" is set to "Yes", the two parameter groups "Top limit value" and "Bottom limit value" are created along with two additional 1 bit objects. These objects can send telegrams on exceeding or undershooting the limit values.

The two limit values can be activated or deactivated independently of each other and can also be fixed or changed by the user using one of the function buttons. Adjustable hystereses and transmission delays can avoid frequent switching and limit the bus load.

Light scene:

A display element with the "Light scene" function does not possess its own communication object.

It displays the name of the last scene opened on the panel.

Date:

A display element with the "Date" function can either show the internally saved date of the real time clock of the panel or, alternatively, the value of a separate 3 byte communication object.

The type of display is set in the parameter group "Date / Time" in the top main node of the ETS plug-in.

Time:

A display element with the "Time" function can either show the internally saved time of the real time clock of the panel or, alternatively, the value of a separate 3 byte communication object.

The type of display is set in the parameter group "Date / Time" in the top main node of the ETS plug-in.

ASCII text:

A display element with the "ASCII text" function displays the value of a 14 byte communication object.

The parameter "Length of ASCII text" limits the maximum number of characters shown. If, for example, the value "10" is displayed here, and the object receives a longer text, then it is cut off after the tenth character when displayed.

Datalogger display:

The datalogger display offers the option of displaying various formats of recorded data on the device. In so doing, the data telegrams received from the KNX/EIB are 'compressed' at set intervals and saved in a datalogger channel of the panel.

The recorded data is displayed using a display function of a display element, in which the data is shown as a curve in an X-Y chart (figure 13).

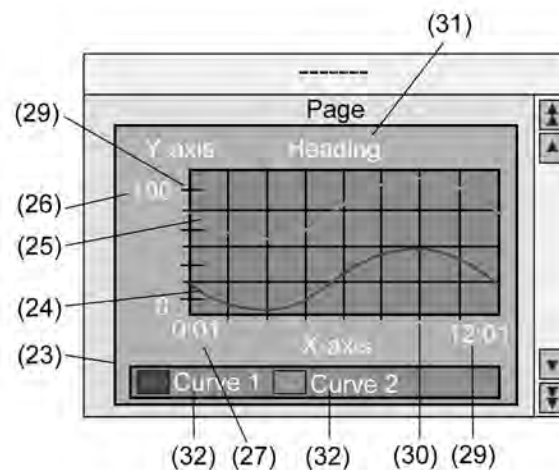

Figure 13: Datalogger display in a display element

Up to two datalogger channels can be displayed as curves (24) & (25) in a display element (23). The curves to be displayed are selected using the parameters "Curve 1: datalogger channel" and "Curve 2: datalogger channel". Within a datalogger display element, only those channels with the same recording periods can be displayed.

- i** The diagram size is directly affected by the size of the display element. Here, the minimum size should be maintained, according to the information shown and the scaling of the axes. If the minimum size is undershot, then it will not be possible to show the diagram on the panel display. In this case, the appropriate display element is filled with a cross.

The Y axis (26) can be scaled dynamically according to the values to be displayed (specified by minimum and maximum values of the recording period) or, alternatively, can be permanently configured in a value range. If the scaling of the Y axis is fixed, and there is a data value outside the specified minimum or maximum limits, then the data value curve is drawn in vertically upwards or downwards from the two neighbouring data points.

The scaling of the X axis is automatically specified by the configured recording period and the resulting time intervals of a datalogger channel. At the bottom left side of the X axis, the diagram always displays the time of the measured value of the first successfully evaluated interval of the previous recording period (27). The data value curve begins at this time. The bottom right item of the X axis displays the time at which the measured value of the last interval of the recording period was recorded (29). If only one interval was recorded, then the two displayed times are the same.

The formatting of the date and time is specified in the top parameter node of the plug-in using the "Date display format" and "Time display format" parameters. The data - partially with special formatting - is only displayed for recording periods lasting several days, weeks or months. The time is only displayed on the X axis when the recording period is set to "Hour" or "Day". Both axes can be given subdivisions (29) and additional lines (30) to simplify the legibility of the diagrams.

In the parameter group of the datalogger display, it is possible to configure a heading for the diagram (31) and names for each curve (32). In addition, "reinforcement" and "offset" can be added to the measured values of a channel to allow the option of modification of the desired measured value ranges in the diagram.

In addition, the datalogger display parameters can be used to specify which recorded data value is to be displayed in the diagram as the "curve type" (maximum value, minimum value or average value). When a datalogger channel is displayed with differentials in the data value recording, it is not possible to select the curve type as there can only be one differential value displayed for each interval.

A maximum of four datalogger displays can be configured on a screen page. A total of 50 datalogger displays can be created in the panel and distributed to different pages.

- i** The functionality of the datalogger, in particular the configuration of the datalogger channels, is dealt with in more detail in the "Datalogger" chapter of this documentation (see page 99).

Access check:

A display element with the "Access check" function possesses a 4 bit communication object. In the communication object, three bytes represent a code number and one byte contains various information, encoded by bit.

The other parameters are used to define whether the code number is displayed or a text corresponding to a bit from the status byte.

Restraint:

A display element with the "Restraint" function possesses a 1 bit object and a 2 bit object. It can display texts for the four possible values of the 2 bit object. The value of the 1 bit object is not displayed.

Operating mode switch:

Depending on the "Operating mode switch via" parameter, a display element with the "Operating mode switch" function will have one 1 byte object or four 1 bit objects.

When using the 1 byte object, the display element can display five operating statuses...

- 0 = Automatic mode
- 1 = Comfort mode
- 2 = Standby mode
- 3 = Night mode
- 4 = Frost/heat protection

When using the four 1 bit objects, these have the following internal ranking...

- Frost/heat protection (highest priority)
- Comfort
- Standby
- Night (lowest priority)

The object with the highest priority, with the value "1" determines the operating mode shown by the display element. If all four objects have the value "0", the display then switches to Comfort mode.

Collective feedback:

After central commands or the return of bus voltage, the telegram load of a bus line is usually high, as many bus devices, such as switching actuators, transmit the status of their communication objects as feedback. This effect increases when each switching channel of an actuator initialises in this manner. To keep the telegram load low during 'bus initialisation', collective feedback can be used for some actuators. The collective feedback summarises the switching status of all the outputs of an actuator in just one telegram. The 32 bit communication object "Collective feedback" contains bit-orientated feedback information of up to 16 switching channels (figure 14).

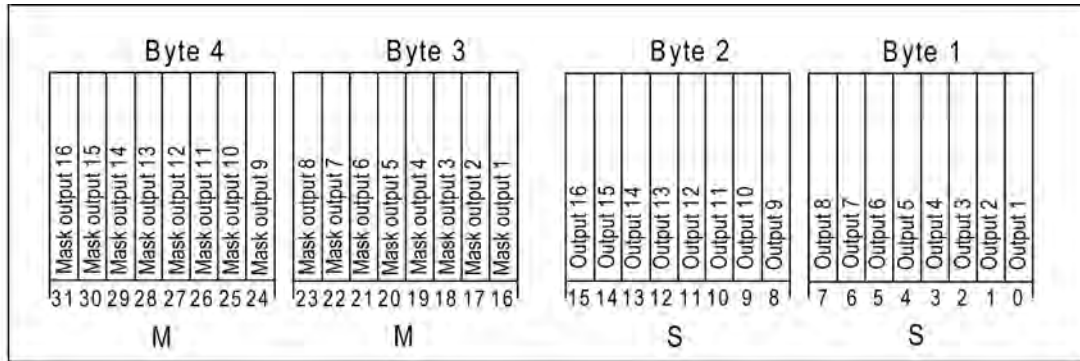

Figure 14: Telegram structure of collective feedback

It is possible to show up to 16 different switching states logically in a telegram. In so doing, each output possesses a bit, which signals the switching state ("S bit), and an additional bit, which defines the masking ("M" bit). The "S" bits correspond to the logical switching states of the outputs and are either "1" (switched on) or "0" (switched off). The "M" bits are "1" when the actuator possesses this output. In the same way, the "M" bits are "0" when the appropriate output is not available on the actuator. In the latter case, the corresponding "S" bits are continuously "0" as there is no switching state.

Example: with a 16x switching actuator, all the 16 M bits are set in a telegram as this actuator possesses all the channels which can be shown in the collective feedback. By contrast, with an 8x actuator only the first lower 8 M bits (byte 3) are set, as this actuator only possesses 8 channels. The top 8 M bits (byte 4) are thus set to "0" in the collective feedback telegram. For actuators with a different amount of channels, the number of M bits behaves in the same way.

The panel can display the switching state of one actuator channel of the collective feedback in a display element. The channel of the collective feedback which is then evaluated is determined by the "Channel to be evaluated" parameter (1... 16) in the parameter group of the appropriate display element. The display element only evaluates the specified channel in the collective feedback telegram, i.e. it inserts the appropriate M bit and S bit .

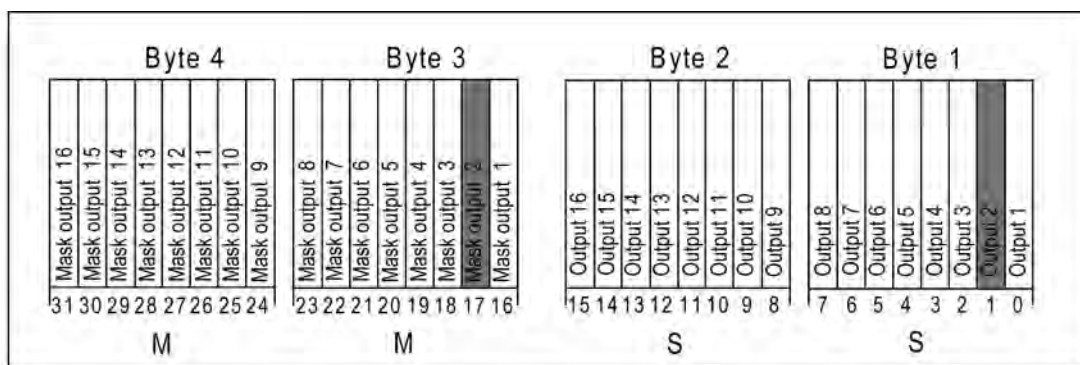

Figure 15: M bit and S bit of a display element to be evaluated

Only when the read-in M bit is set in the telegram, i.e. the channel is available on the actuator, does the panel evaluate the corresponding S bit and displays the status 'On' or 'Off' in the display element. Either image texts or status icons can be displayed as text or an icon, according to the status display.

If the M bit of the channel to be evaluated is not set in the collective feedback telegram, i.e. the appropriate actuator channel does exist, then the panel displays the status 'Invalid' in the display element. This is a case of bad programming.

- i Ensure that a unique group address is used in the ETS project for the collective feedback of an actuator. This group address must be connected with the collective feedback object of the actuator and with the collective feedback objects of various display elements of the panel (max. 16). Ensure that, at no time, more than one actuator is connected with a collective feedback group address. If the collective feedback of various actuators is to be displayed on the panel, then multiple group address must be used.

Dimmer actuator load type:

Some KNX/EIB dimmer actuators permit feedback of the load type set or measured at the load output to the bus. In this way, one can identify the dimming principle according to which the dimmer output is working. With universal dimmer actuators, it is thus possible to determine whether the dimmer output has adjusted to forward phase or inverse phase operation. Feedback of the load type is provided using a 1 byte object in each dimmer actuator channel. The object must possess the value encoding shown in Table 2.

Object value	Meaning
0	Load type undefined
1	Load type capacitive / ohmic
2	Load type, inductive
3	Load type, universal, dimmer actuator adjusted to capacitive or ohmic load
4	Load type, universal, dimmer actuator adjusted to inductive load
5...255	Not used

Table 2: meaning of the object values for a dimmer actuator load type

The panel is able to display the feedback of a load type in a display element. In this case various image texts or status icons can be configured in the parameter group of the appropriate display element according to the load type meanings shown in Table 2. When the panel receives a telegram value to which no load type meaning is assigned (values 5...255), then the panel will only show dashes in the display element.

Operating function

Each display element can also be configured for an operating function in addition to the display function. Four function buttons can be shown at the bottom edge of the panel for each display element and can be operated by touching them (figure 16). The operating function of a display element is only available when the parameter "Element selectable" is set to "Yes".

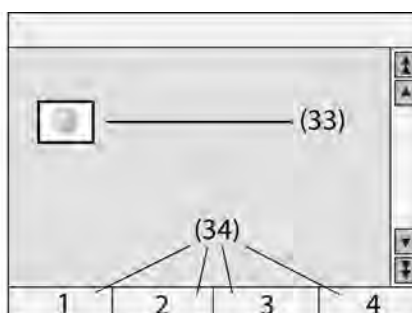

Figure 16: Function buttons of a display element

The parameters of the display elements make a distinction between two possible types of operation...

- Single click operation:
Tapping the display element (33) automatically executes the function of function button 1. For this, it is not necessary to have the four function buttons (34) of this display element visible at the bottom edge of the screen. The parameter "Hide function keys" in the parameter group of the display element specifies whether the appropriate buttons are visible for a selected element or not. If all the function buttons are visible, then additional buttons of the element can be operated after clicking the display element and automatic execution of the function of button 1.
If the scroll bar is used, in order to switch between the different display elements using the single arrows, the display elements are simply selected without direct execution of the function.
- Two click operation:
Tapping the display element (33) or selecting the scroll bar makes the four function buttons (34) of the display element visible without directly executing a function. Only when one of the function buttons is actuated is the stored function executed.

The individual function buttons can be configured independently with the following functions.

Switching:

On pressing and / or releasing the button, the panel can transmit no telegram, switch on, switch off or switch.

The telegram is transmitted via a separate button object.

If the display element is configured for the display function "Switching", then the function buttons can be also be configured for the function "Switching function of the display element". In this case, the function button affects the communication object of the display element and not a separate object.

Blind:

The parameter "Blind function" determines the direction (Up, Down, Toggle) in which the drive to be controlled should travel. If the setting is "Toggle", the direction is changed after long actuation. In addition, the parameters can be adjusted to make a distinction between lamella adjustment (brief actuation) and movement (long actuation).

The telegram is transmitted via two separate button objects (long-time operation and short-time operation).

If the display element is configured for the display function "Blind", then the function buttons can be also be configured for the function "Blind function of the display element". In this case, the function button affects the communication objects of the display element and not separate elements. In addition, in this case, the time settings of the display element are used.

Dimming:

The parameter "Dimming button function" determines which switching or dimming commands the panel sends to the bus when the button is pressed for a long or short time. In addition, the parameters can be adjusted to make a distinction between switching (brief actuation) and dimming (long actuation).

The telegram is transmitted via two separate button objects (switching and dimming).

Alternatively, a 1 byte object with a constant brightness value can be used (parameter "Dimming button function" = "Brightness value"). In this case, the value to be transmitted on pressing the button can be configured.

The telegram is then transmitted via a separate button object.

If the display element is configured for the display function "Dimming", then the function buttons can be also be configured for the function "Dimming function of the display element". In this case, the function button affects the communication objects of the display element and not separate elements. In addition, in this case, the time settings of the display element are used.

Value:

The "Value display" parameter specifies the type of the communication object and the valid value range. With a 1 byte object matching Type 5,001...5,004, the value to be transmitted can be configured as an integer (0 ... 255), a percentage (0 ... 100%) or an angle (0 ... 360°). With all the other data point types, the entered value is transmitted immediately.

The telegram is then transmitted via a separate button object.

If the display element is configured for the display function "Value", then the function buttons can be also be configured for the function "Value display of the display element". In this case, the "Value function" parameter specifies whether a constant value is transmitted on each actuation or whether the user can edit the value on the panel later. In the former case, the constant value is specified with the next parameter. In the latter case, a minimum value and a maximum value are entered in the parameter configuration. If the user enters a value later using the on-screen numeric keypad or a slider, there will be a test to see if the value is within the specified limits. If this is not the case, the appropriate minimum or maximum value is used. If the display element is modified using the "Offset" and "Reinforcement" parameters before being shown on the screen, this calculation is also used on the button function before the new value is transmitted.

In the case of the function "Value display of the display element", the function button affects the communication object of the display element and not a separate object.

Light scene:

When the button is actuated, one of the internally managed light scenes is opened. The parameter "Light scene" specifies which light scene is opened. The light scenes must be created in the ETS plug-in in the parameter node "Light scene -> Light scene collection -> Light scene page ..." before they can be selected using the "Light scene" parameter.

Restraint:

With this button function, two communication objects are visible. The parameter "Button function" specifies which of the two communication objects is to transmit a telegram. The possible settings are...

No function: no telegram is transmitted.

On: the 2 bit object transmits a telegram with which restraint is deactivated. The 1 bit object transmits a switch-on telegram.

Off: the 2 bit object transmits a telegram with which restraint is deactivated. The 1 bit object transmits a switch-off telegram.

Toggle: the 2 bit object transmits a telegram with which restraint is deactivated. The value of the 1 bit object is inverted and transmitted.

Restraint ON: the 2 bit object transmits a telegram with which causes switch-on with a higher priority. The value of the 1 bit object is not relevant, it does not transmit a telegram.

Restraint OFF: the 2 bit object transmits a telegram with which causes switch-off with a higher priority. The value of the 1 bit object is not relevant, it does not transmit a telegram.

Restraint off: the 2 bit object transmits a telegram with which restraint is deactivated. The 1 bit object does not transmit a telegram.

The telegram is transmitted via a separate button object.

If the display element is configured for the display function "Restraint", then the function buttons can be also be configured for the function "Restraint function of the display element". In this case, the function button affects the communication objects of the display element and not separate elements.

Open page:

If "Open page" is set as the function of a button, the parameter "Jump to page" can be used to specify which page is displayed when the button is actuated. The parameter "Jump to page" offers a list with the user pages currently created in the project, the pages predefined in the system and the presetting "Return".

When a page is opened, the system notes on which page it is opened. The "Return" automatically switched back to this page. Only the last page is ever saved. If "Return" is entered on two or more pages, it may cause the function to jump between these pages.

If a password level is assigned to a page and the page to be opened has a higher password level, the new password of the higher level must be entered using the on-screen numeric keypad before the switch is made. If an incorrect password is entered, the page change is not

carried out. There is an automatic return. After 30 seconds with no password entered, a automatic return also takes place. If a password level is assigned to a page and the page to be opened has a lower password level, then the page change takes place without the password of the lower level being entered. The current password level is automatically reset to the lower password level.

Operating mode switch of the display element:

The button function for switching the operating mode of a room temperature controller is only available when the display element is set to "Operating mode switch". The parameter "Function on actuation" can be used to select a specific operating mode ("Automatic mode", "Comfort mode", "Standby mode", "Night mode", "Frost/heat protection") or also "No function". "Automatic mode" can only be selected in a KONNEX operating mode switch.

4.2.4.2.3 Status line

On each screen page, the visibility of the status line on the top edge of the screen can be switched on or off. The structure of the status line is the same on every page. Up to 10 status elements can be created in the status line. The individual elements are centred vertically in the status line. The horizontal positions of the individual status elements can be specified individually. The preview window of the ETS plug-in can be used to check that the status elements do not overlap.

The following functions can be selected for the individual status elements...

- Event display
- Collective fault message
- Value display
- Date
- Time
- ASCII text

The collective fault message shows that at least one error fault message is active. An "Event display" status element corresponds to a display element with the function "Switching". The status elements "Value", "Date", "Time" and "ASCII text" correspond to the display elements of the same name. This means that separate communication objects for status control may be available, depending on the configured function of a status element.

4.2.4.2.4 Copying display elements and pages

The manual creation and alignment of a large number of display elements may take some considerable time. In addition, it may be that the appearance of pages of the same structure will differ slightly and annoy the user.

For this reason, it is wise to create sample pages with typical arrangements (one-column, two-column) of the display elements. These can be copied via the clipboard. The sample pages can also be copied to a separate file, from which they can be reinserted in the project planning using the command "Insert from file" (click the right mousebutton). The display elements can also be copied with their settings. On insertion, the ETS plug-in positions the display element at its original position. This must then be corrected manually.

4.2.4.2.5 Connecting pages

There are two options for switching between the individual screen pages...

- The function buttons of the display elements can be used to plan defined jumps. When these display elements are copied, the ETS plug-in replaces these openings with "Return".
- The pages can be connected using the "Previous page" and "Next page" settings. The page is then changed using the double arrow of the scroll bar. These settings are then applied without modification on copying.

In addition, it is possible to switch between individual screen pages using a separate communication object (see chapter 4.2.4.2.1. General page structure).

4.2.4.3 Service page

4.2.4.3.1 Structure

The Service page allows the user to obtain internal system information and to make personal changes.

The Service page is divided into three areas...

- Area 1: "Display settings"
- Area 2: "System settings"
- Area 3: "Administrator"

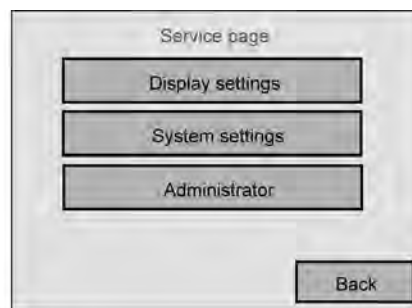

Figure 17: Service page

To open the Service page, there must be a display element on another user page of the panel, from which a button uses the "Open page" function to jump to the Service page. Various points of the Service page can be configured in the parameter node of the same name in the ETS plug-in. This means that other names can be given to the areas, allowing user-defined modifications. The three areas of the Service pages can also be assigned individual password levels, just as with the pages created for specific projects.

- i** Neither the scroll bar nor the status line are visible on the service page and subordinate system pages.

4.2.4.3.2 Display and system settings

Display settings

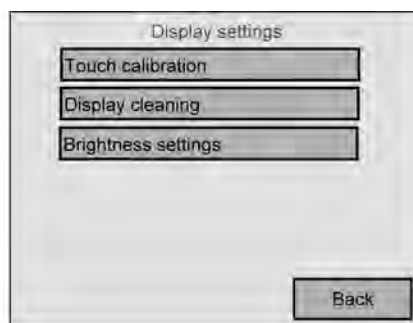

Figure 18: Display settings

The display can be adjusted in the first area of the Service page.

The following functions can be configured...

- Touch calibration: here the touch area can be compared to the display if the user has problems with the operation of certain icons.
- Display cleaning: the display and the touch function are switched off for 60 seconds so that functions are not triggered by mistake during cleaning.
- Brightness setting: the background lighting can be adjusted in three levels. The set value is transferred as the basic brightness and thus overwrites the value configured in the ETS plug-in until the next programming operation.

System settings



Figure 19: System settings

Various system settings can be made in the second area of the Service page.

The following functions can be configured...

- Date: the system date can be entered manually here. This item is only required when there is no higher level clock for synchronisation in the KNX/EIB system.
- Time: the system time can be entered manually here. This item is only required when there is no higher level clock for synchronisation in the KNX/EIB system. The symbol "*" is displayed directly behind the time when summer time is active.
- Weekday: the current weekday can be entered manually here. This item is only required when there is no higher level clock for synchronisation in the KNX/EIB system.
- Message list: a list of the fault messages is managed here along with details of their acknowledgement (see chapter 4.2.4.4. Fault messages).

- Service address: an address can be shown at this point in the panel display, which the user can contact should there be problems in the KNX/EIB system or in the panel. The service address is entered in the ETS plug-in.
- Colour setting: here the user can select a new colour scheme to be used on all the pages using the system colour scheme. Pages, to which a specific colour scheme is assigned, cannot be changed by the colour setting at this point. The "Colour setting" button is only shown in the system settings when the parameter "Allow colour scheme selection" in the "Service page" parameter node of the ETS plug-in is set to "Yes".

4.2.4.3.3 Administrator settings



Figure 20: Administrator settings

In the third area of the Service page, the administrator of the panel can make various configurations.

The following functions can be configured...

- Default setting: here the panel can be reset to the default settings. For security reasons, there is an explicit query. The following data is then reset:
RSS newsfeed and e-mail configuration data, recordings by the datalogger, light scenes are deleted (names and values), timer switch data is deleted, the selected colour scheme and basic brightness are reset, fault messages are deleted, calibration data is reset to the standard setting. The function is noted in the history memory. Project data is maintained when the default settings are applied.
- Passwords: the passwords for the various password levels can be changed here (see chapter 4.2.4.3.4. Passwords).
- Version: detailed information on the hardware and software of the panel is displayed here.
- IP settings: the IP communication parameters of the panel can be set here. If necessary, these settings must be agreed with the local network support (network administrator) (see chapter 4.2.4.3.5. IP settings).
- History: a list of internal device operations is displayed here. An operation entered in the history list could be a device reset or a programming operation. Various error states are logged in the history. A distinction is primarily made between two types of list entries. On the one hand, there are entries affecting internal device functions and the USB and KNX/EIB functions (see Table 3), On the other, there may be list entries describing operations for IP communication and functionalities. With the IP operations, a distinction is made as to whether the event to be logged affects general communication via the Ethernet interface (see Table 4 & 5.x) or the RSS newsfeeds (see Table 6). IP operations are logged in the history as follows...
 - **IP E:** <Error code> **ID** <ID code> for operations which generally affect IP communication
 - **IP RSS** <RSS feed number> **Feed:** <RSS error code> for operations affecting the RSS newsfeeds

The Tables 4, 5.x & 6 contain a description of the appropriate IP error codes and ID codes.

Text displayed in the history	Meaning
Restart	Device restart
System: initialised	System initialised successfully
WDT: reset	Watchdog Timer Reset (device restart)
HW: reset	Hardware Reset (button actuated)
GDI: init error	Initialisation of the graphic system failed
History: CRC error	Checksum error, history memory
History: reset	History memory reset
Param: CRC error	Parameter checksum error (stops a device start)
GW: CRC error	Checksum error, limit values
GW: reset	Limit values reset
SU: CRC error	Checksum error, timer switch
Timer: reset	Timer switch data reset
LS: CRC error	Checksum error, light scenes
LS: reset	Light scene data reset
PW: CRC error	Checksum error, passwords
PW: reset	Passwords reset
Display: CRC error	Checksum error, display settings
ML: reset	Error memory deleted
Clock: error	Invalid date / time
BCU: error	KNX controller cannot be contacted
KNX: buffer error	KNX buffer not free
USB: stop appl	USB Download: stop application
USB: reboot	USB Download: reboot
KNX: stop appl	KNX Download: stop application
KNX: reboot	KNX Download: reboot
Timeout: reboot	Download timeout: reboot
BCU: reset	BCU reset: executed
BCU: power down	BCU power down (bus voltage failure)
BCU: start up	BCU start up
Defaults: reset	Reset to default setting
Calib. CRC error	Error, touch calibration data
Calibration: OK	Touch calibration OK
Calibration: error	Touch calibration faulty

Table 3: operations of internal device functions and USB and KNX/EIB functions for the history list

IP error code	Meaning
0x00	Undefined internal error
0x01	Cannot contact communication target
0x02	Connection lost
0x03	No authentication possible
0x04	Parser error
0x05	No Ethernet connection
0x06	Wait for confirmation
0x07	Unprocessed operation
0x08	Invalid data
0x09	Invalid packet length
0x0A	Incorrect checksum
0x0B	Incorrect URL
0x0C	Do not wait for confirmation
0x0D	Connection being used
0x0E	Cannot resolve DNS
0x0F	Confirmation timeout
0x10	HTTP not OK
0x11	e-mail response not OK
0x12	e-mail answer timeout
0x13	SMTP timeout

Table 4: IP error codes for history list

IP ID code	Meaning
0x20	Configuration data
0x21	Configuration connection open
0x22	Configuration connection closed
0x23	Configuration confirmation

Table 5.1: IP ID codes (configuration) for history list

IP ID code	Meaning
0x30	Programming data
0x31	Programming open
0x32	Programming closed
0x3F	Programming confirmation

Table 5.2: IP ID codes (programming) for history list

IP ID code	Meaning
0x40	e-mail test, inbox
0x41	e-mail connection open
0x42	e-mail connection closed
0x43	e-mail, new message, info 1
0x44	e-mail, new message, info 2
0x45	e-mail, open message text
0x46	e-mail message, "only text" area
0x47	Delete e-mail message
0x4E	e-mail message not found
0x4F	e-mail confirmation

Table 5.3: IP ID codes (e-mail) for history list

IP ID code	Meaning
0x50	Remote operation, check data
0x51	Remote operation, check connection open
0x52	Remote operation, check connection closed
0x5F	Remote operation, check confirmation

Table 5.4: IP ID codes (remote operation) for history list

IP ID code	Meaning
0x60	SMTP initialisation request
0x61	SMTP message data
0x62	SMTP delivery status
0x6F	SMTP confirmation

Table 5.5: IP ID codes (SMTP) for history list

IP ID code	Meaning
0x70	HTTP enquiry
0x71	HTTP response, message header
0x72	HTTP response, text message
0x73	HTTP excessive data
0x74	HTTP response end
0x7F	HTTP confirmation

Table 5.6: IP ID codes (HTTP) for history list

IP ID code	Meaning
0x80	SNTP enquiry time
0x81	SNTP time data
0x8F	SNTP confirmation

Table 5.7: IP ID codes (SNTP) for history list

IP ID code	Meaning
0xF0	SETUP network
0xF1	SETUP Telnet
0xF2	SETUP remote ports
0xF3	SETUP MAC
0xF4	SETUP all data
0xFD	SETUP read request
0xFF	SETUP confirmation

Table 5.8: IP ID codes (SETUP) for history list

RSS error code	Meaning
300	Selection not clear
301	Source moved permanently
400	Invalid enquiry
401	Unauthorised
402	Fee necessary
403	Forbidden
404	Not found
405	Method not permitted
406	Unacceptable
407	Proxy authentication required
408	Enquiry time exceeded
409	Access conflict
410	Source no longer exists
412	Precondition not available
500	Internal server error
501	Not implemented
502	Gateway without function
503	Service not available
504	Gateway timeout
505	HTTP version not supported

Table 6: RSS error codes for history list

4.2.4.3.4 Passwords

The passwords are not defined in the ETS plug-in. They are only saved in the panel and must be changed there. The default passwords of the four levels are...

- Level 1: "11111"
- Level 2: "22222"
- Level 3: "33333"
- Level 4: "44444"

The set passwords can be changed using the "Adjust passwords" page (Service page -> Administrator -> Passwords). Tapping a password level causes the on-screen numeric keypad to open, giving the option of entering and saving a new password or cancelling the change. To ensure that the password was saved correctly, it is shown in plain text on changing it. As soon as a password must be entered to open a page, asterisks are displayed instead of the numbers.

The passwords changed on site are not overwritten by the ETS or the plug-in during a panel programming operation, even if the option "Transmit all on next download" was selected in the project planning software (menu "Settings -> Options -> Hardware").

A password reset - should it become necessary - can be carried out as follows:

Firstly, a new device must be created in the ETS. Then a page must be created in the plug-in configuration of this new device, for which a jump to the Service page is created. The System page must be configured without any password protection. Load the project into the device (programming operation) and then change the passwords on the System page. Then the original page can be reloaded into the panel.

4.2.4.3.5 IP settings

Basic principles

If the panel is connected to a local network via the Ethernet interface and the "e-mail" and "RSS newsfeeds" services, various IP configuration parameters must be set. In addition, the same IP settings are required if the panel is to be operated 'remotely' by the additional PC Client software. The IP parameters are set either on site on the panel on the screen page "IP settings" (Service page -> Administrator -> IP settings) or using the PC Client software for remote operation.

For all the services, the panel communications with other network subscribers or with the Internet via the higher-level TCP-IP communication protocol (Transport Control Protocol / Internal Protocol) allowing secure data communication, independent of hardware and software. For this protocol to function correctly - even beyond local network borders - the following network settings must be made...

IP address:

Each subscriber in a network (LAN, WAN) has their own unique IP address. This Internet address is a 32 bit value, always specified in the form of four decimal numbers separated by dots (8 bit values) for easier comprehension. This method of display is called dot notation. Here is an example of a possible IP address of the panel: 192.168.1.2 .

The panel also requires a clear IP address for identification and communication in the local network.

Subnet mask:

The Internet address is subdivided into the Net ID and Host ID to distinguish between the individual networks. The Net ID addresses the network and the Host ID addresses the network subscribers (e.g. PC or panel). Telephone numbers are structured in a similar way. Here too, a distinction is made between the dialling code and the actual telephone number. The Net ID shows whether the recipient, to whom a network connection is to be setup, is in the same individual network as the sender or not. If this part of the IP address is the same for both the sender and the recipient, then both communication partners are located in the same network. If it does not match, then the recipient is located in a different network.

Which part of the IP address belonging to the Net ID and which to the Host ID depends on the size of the individual network (subnet) and is primarily determined by the subnet mask.

Just like the IP address, the subnet mask is also a 32 bit value, shown in dot notation. The panel also requires a subnet mask in the IP configuration to detect the relationship to the network topology.

Standard gateway:

If the subnet mask is viewed in binary, then the section of the Net ID is filled with ones and the section of the Host ID with zeroes. With each data packet to be sent, the sender compare their own IP address with that of the recipient. In so doing, the bits of the Host ID beyond the part of the subnet mask filled with zeroes is hidden. If the evaluated bits of the two IP address are identical, then the network subscriber to be contacted is in the same subnet. If just one of the evaluated bits is different, then the selected network subscriber is not located in the same subnet. In this case, the data packet must be handed over to a standard gateway to be switched into the target network - for example, the Internet. In many cases, the standard gateway is - and this occurs extremely often in private networks - a DSL router, which connects the local network with the Internet.

The panel also requires the IP address of a standard gateway when communication beyond the borders of the local network is necessary.

DNS Server:

There are millions of IP addresses on the Internet. Users would have difficulty handling the different addresses - even in smaller home networks - because the long numbers are either very difficult to remember or are completely unknown. This is where the DNS (Domain Name

System) helps. Here, allocations of IP addresses and domain names are stored on DNS Servers, are constantly managed and polled as necessary. The DNS can be seen as the telephone directory of the Internet.

The panel also allows the user or the installation engineer as an administrator to enter domain names rather than direct IP addresses at some points. For this reason, the panel, just like a web browser, also needs the valid address of a DNS Server, in order to poll the names there and then resolve the IP address. Therefore, a DNS Server must also be entered in the IP configuration of the panel.

- i** Valid IP addresses for DNS Servers are available from the network administrator or the responsible Internet service provider (ISP). In some cases, mini DNS Servers are already integrated in the Internet route of the network. However, this depends on the router used. In such cases, the address of the DNS Server is the same as the address of the standard gateway.

DHCP:

As described above, to communicate with other network subscribers, the panel needs their IP address, its own subnet mask and, if necessary, the IP address of an available gateway and of a DNS Server. These addresses can always be specified during panel commissioning and entered in the device configuration. For this, the network administrator must hand over the information to the operator or the installation engineer.

In larger networks, this method soon causes a lot of configuration and management work. For this reason, amongst others, the use of DHCP (Dynamic Host Control Protocol) is advisable.

With DHCP, network settings of the individual terminals, such as the IP addresses required, can be agreed automatically and in a standardised manner, and configured centrally. To use DHCP, at least one DHCP Server is required in the network, in order to manage the configuration data for a specified IP address range. As a DHCP-compatible terminal, every time the power supply is switched on, the panel polls its own IP address from the DHCP Server along with the corresponding parameters such as subnet mask, standard gateway and DNS address. Modern routers, used, for example, to connect a single network to the Internet, often in conjunction with DSL connection in private homes, usually have a integrated DHCP Server. This means that DHCP can also be used in smaller networks. On the panel, the use of DHCP is activated and configured by default. In this way, the panel can be integrated in larger networks using Plug & Play.

AutoIP for DHCP:

In some cases, the panel may load a network configuration through DHCP, a configuration for which at that point no DHCP Server can be contacted. In this case, the panel assigns itself an IP address from a predefined AutoIP range and initialises itself with the self-assigned address. In so doing, the panel checks to see if the address is not already used by another network subscriber. The following values are set for AutoIP (see Table 7).

IP configuration	Value range / Value
IP address	169.254.x.y
Subnet mask	255.255.0.0
IP address of gateway	0.0.0.0 (not set / no gateway available)
DHCP	On, but not functioning

Table 7: IP configuration for AutoIP

The Host ID part of the IP address (x, y) is selected at random. The AutoIP configuration remains valid until the panel reinitialises after switching the power supply off and on again or after switching on the DHCP with subsequent saving on the "IP settings" page.

Ports:

Ports are address components used in network protocols, in order to assign data packets to the correct services. The size of the port number is 16 bits, i.e. it can accept values between 0 and 65535. Certain applications used permanently assigned, generally known port numbers.

Usually, these are between 0 and 1023, and are termed 'well known' ports (e.g. HTTP port 80, FTP port 21). The registered ports are between port 1024 and 49151. These can be registered as necessary by applications' manufacturers for their own protocols, like domain names. The remaining ports to port 65535 are so-called dynamic and/or private ports. These can be used variably, as they are not registered and thus do not belong to any application.

The panel also uses various ports for special IP connections to the panel which can primarily be set up using the additional PC Client software (see chapter 4.3.1. Introduction, installation and program start). For example, with remote operation, port "3261" is used. For configuration along the Ethernet cable, port "3262" is used, and port "3263" is used for Ethernet firmware or project data downloads.

The named port addresses are predefined in the factory settings of the panel. However, during IP configuration, they can be changed to any other values within the approved port value range, if the prespecified values are already used elsewhere in the network.

Editing addresses, ports and DHCP

To enter the IP addresses described above, tap the appropriate fields in the "IP settings" menu on the panel to access the subnet mask and the ports. The values are entered directly via the touch display using the on-screen numeric keypad. "Save" exits the input screen, and the edited values are only transferred to the device memory when "Save" is pressed a second time on the "IP settings" screen page. "Cancel" terminates the entry.

However, it is only possible to input the IP addresses and the subnet mask when DHCP is switched off. DHCP is switched on on the panel by default, meaning that the IP addresses and the subnet mask are assigned automatically. Therefore the appropriate values cannot be edited on the "IP settings" screen page when DHCP is switched on. The IP address of the panel assigned via DHCP after a successful initialisation operation is displayed in the "IP address" line. Any further address lines are labelled "Automatic".

The DHCP functionality can be switched off at a later time by tapping "DHCP" on the touch screen. When DHCP is switched back on (status change Off -> On), the panel actively asks the DHCP Server via DHCP about the IP configuration parameters as soon as the "Save" button is actuated on the screen page. The DHCP configuration operation takes approx. 30 s. Only after this time can the updated configuration parameters be seen on the screen under "IP settings".

- i** The set IP addresses and the subnet are stored in non-volatile memory in the panel. Should the power supply fail or programming is carried out via the ETS or the plug-in, the set values remain intact.
When DHCP is activated, a new configuration comparison with the DHCP Server is carried out after a reset (power supply is switched on). The automatic comparison does not take place if, when the power supply is switched on, the Ethernet connector is removed from the panel and reconnected, for example when changing networks. In this case the power supply must always be switched off and on again, so that the panel carries out a comparison with the DHCP Server on switch-on. An ETS or plug-in programming operation also does not automatically cause a DHCP comparison if the power supply remains uninterrupted.
- i** All the IP configuration parameters can also be edited in the additional PC Client software (see chapter 4.3.1. Introduction, installation and program start).
- i** In administrated networks, it may be necessary to know the MAC address of the panel (Media Access Control). This address is permanently programmed into the device memory when the device is manufactured and thus cannot be edited. The MAC address can be viewed on the Service page of a panel under "Area 3 <Administrator> -> Version".

4.2.4.4 Fault messages

Fault messages

In contrast to the normal display functions, which only show the status at any given moment, fault messages have the following distinctive features...

- The piezo buzzer can sound automatically.
- A specific message page can be display, irrespective of the current screen page.
- The user can demand an acknowledgement.
- Faults can be entered in a separate message list.

4.2.4.4.1 Creating fault messages and the message window

Creating a fault message

Up to 50 different fault messages can be managed in the ETS plug-in. Fault messages are added by clicking the right mousebutton in the parameter node of the same name. A 1 bit object "Fault signal object" is created for each fault message added. The parameters of a fault message are displayed in the corresponding parameter group.

The parameter "Activation by object value" defines when a message is activated via the fault signal object (e.g. activation through "1" telegram). The opposite value deactivates the message (e.g. deactivation through "0" telegram). In addition, a text can be specified for each fault, allowing the fault message to be identified later. The parameter "Acoustic signal" decides whether the piezo buzzer integrated in the panel sounds when there is an active fault message, or remains silent.

If individual fault messages are particularly important or multiple fault messages can be traced back to similar sources (e.g. smoke detectors), this may block other fault messages in the panel. Clicking the parameter field "In case of fault message, blockage of additional fault message windows" opens a separate dialog, in which the messages to be blocked can be selected from the list of all the fault messages.

When the panel receives a fault message, it can open a message window if required (figure 21).

Message window

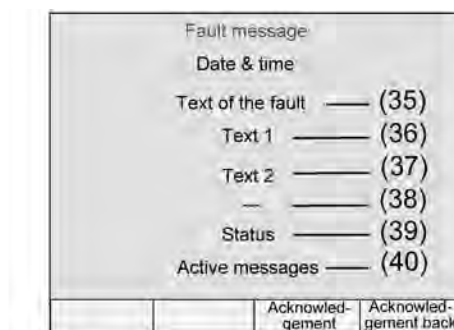

Figure 21: Message window of a fault message

The text of the fault message is display in the first line of the message window (35). This text is also accepted in the message list, if an entry is to be made.

Lines 2 (36) and 3 (37) show a display text which can be freely configured in the ETS plug-in (each max. 23 characters).

The fourth line (38) can, if so required, display an external text, received via a separate 14 byte object from the panel. If the external text is used (parameter "Display external text on fault message = Yes"), the panel waits about 500 ms after the activation of the fault message before display the message window. However, the external text can also be received after a delay, as long as the message window is still displayed. If no external text has been received, dashes "----" are shown on the display.

In the fifth line (39) of the message window, the panel displays the status of the fault message

(active, inactive, acknowledged).

The sixth line (40) displays the amount of currently active messages. If additional fault messages arrive, before an existing message window is closed, the existing window is covered by the new window. If more than 20 fault messages are active, when the 21st fault message arrives, the oldest one is deleted and the deleted fault message is then not processed any more (e.g. acknowledgement).

Optionally, the physical address of the device which transmitted and thus activated the fault message on the bus can be displayed in the message window behind the date and time of the fault (parameter "Record sender address = Yes").

The functions of the function buttons of the message window are fixed: button 3 is used to acknowledge a fault message (see chapter 4.2.4.4.2. Acknowledgement and message list) and button 4 is used to acknowledge and also close the message window. Buttons 1 and 2 do not have a function.

- i When the parameter "Open message window" is set to "No" and the acoustic signal is activated, the piezo buzzer will sound when an appropriate fault message telegram arrives, but no message window opens. Acknowledgement is then only possible externally using the appropriate communication object. For this reason, the external acknowledgement must be configured and used in such a configuration (see chapter 4.2.4.4.2. Acknowledgement and message list).

4.2.4.4.2 Acknowledgement and message list

Acknowledgement of a fault message

A fault message can either be acknowledged internally via function button 3 of the message window (internal acknowledgement) or via the bus through a separate 1 bit communication object (external acknowledgement). A fault message must be acknowledged to switch the piezo buzzer off and to close the message window shown when a fault occurs..

- i** The acoustic signalling of a fault using the piezo buzzer or by displaying the message window is parameter-dependent (see chapter 4.2.4.4.1. Creating fault messages and the message window).

With internal acknowledgement, the parameter "Acknowledgement via button" in the parameter group of a fault defines the following acknowledgement properties of the third function button "Acknowledgement" in the message window...

- When the function button 3 is pressed, the acknowledgement is only processed internally. No information is sent to other devices.
- "Sends object value 0", "Sends object value 1" settings: an additional "acknowledgement object" is made visible. When the button is pressed, the acknowledgement is also sent to other devices via this 1 bit object. The telegram polarity of the acknowledgement object is directly defined by the "Acknowledgement via button" parameter.
- "Disabled" settings: internal acknowledgement using function button 3 of the message window is deactivated. This means that function button 3 does not have a function.

An additional 1 bit communication object must be enabled for external acknowledgement. If the parameter "External acknowledgement through object value" is configured to "1 telegram" or "0 telegram", then the fault message can also be acknowledged by other KNX / EIB devices. In this case, the "Acknowledgement receipt object" is display in the ETS plug-in.

If a fault message has been acknowledged, this does not mean that the cause of the fault has automatically been eliminated. For this reason, the fault signal may be presented again after a set time. The cause of a fault is only considered to be eliminated when a telegram is received via the fault message object containing a polarity inverse to that in the telegram activating the fault message (parameter-dependent).

Acknowledgement can also cause an automatic switch to one of the projected user pages in the panel. As with all other page openings, this page must be created in the ETS plug-in so that a page can be specified with the "Open page" parameter and a jump can be executed.

- i** When the parameter "Open message window" of a fault message is set to "No" and the acoustic signal is activated, the piezo buzzer will sound when an appropriate fault message telegram arrives, but no message window opens. Acknowledgement is then only possible externally using the appropriate communication object. For this reason, the external acknowledgement must be configured and used in such a configuration.
- i** When a fault message is acknowledged, an acknowledgement event is logged in the message list (see next section). This logging operation only takes place when a fault message is acknowledged using function button 3 of the message window or is acknowledged externally and not when a message window is closed using button 4 "Acknowledgement / Back".

Message list

If necessary, it can be set in the parameters whether each fault message should be saved in the message list of the panel. The message list is a separate system page which can be reached by opening a page using any function button.

The following events of a fault can be logged in the message list...

- Time of the fault message, logged as "coming",
- Time the fault message is retracted (fault cause eliminated), logged as "going".
- Time of acknowledgement, logged as "acknowledged".

In addition, the "Fault text" is logged and displayed in the message list, thus allowing clear identification.

Which of the three named events is logged in the message list can be configured in the "Message list" parameter group of a fault message.

- i** The message list is deleted during a programming operation of the panel by the ETS or the plug-in. If the power supply fails, the events stored in the message list are not lost.

4.2.4.5 Light scene function

Introduction

The panel can be managed up to 24 light scenes with up to 32 light scene groups (actuator groups). The light scenes can be controlled both using the operation functions of the panel and using an extension object. Control using the extension object is only possible when, in the "Light scenes" parameter node, the "Extension object" parameter is set to "Yes". The extension object can be used both to open and to save the light scenes.

The ETS plug-in automatically assigns the numbers 1 to 24 to the defined light scenes. Other numbers are not supported. When the light scenes are opened, the panel sends a telegram to each light scene group with the value saved in the panel. When the light scenes are changed later, the panel can send a read request to each light scene group and save the responses as new values in non-volatile memory.

Opening and saving light scenes can lead to a short-term increase in bus load. For this reason, it is possible to use the general parameters of the ETS plug-in to specify the time between the individual light scene telegrams (see chapter 4.2.4.1.1. General parameters).

Project planning of the light scene function consists primarily of three steps...

- Adding the light scenes to the plug-in project planning.
- Adding the light scene groups to the plug-in project planning.
- Specifying the light scene values on the panel.

i The following should be observed:

If, after successful commissioning, changes are made to the light scenes or the light scene groups in the ETS plug-in, then these changes must be loaded into the device in a valid way. The light scene configuration is only programmed completely when the parameter "Overwrite light scene name, delete values" in the top parameter node of the plug-in is set to "Yes" (see chapter 4.2.4.1.4. Download behaviour). Any changes made on the panel by the user (light scene values, light scene designations) are lost.

4.2.4.5.1 Adding light scenes and light scene groups

Adding light scenes

Firstly, the light scenes must be created. Three screen pages are available in the ETS plug-in under the node "Light scenes -> Light scene collection". Up to eight light scenes can be added to each of these three pages by clicking the right mouse button. For additional clarity, these light scenes should be given clear designations straight after adding. These designations can be modified at any later time on the panel after commissioning.

On adding, the light scenes receive their light scene number automatically, with which they can be opened later using the extension object. The light scenes do not otherwise possess any additional parameters or configuration options. The light scene groups are later assigned to each light scene, meaning that control is possible by the KNX / EIB actuator groups.

i During panel operation, the three screen pages of the light scene collection can only be reached by jumping to the light scene pages (1...3). Therefore it is necessary to configure at least one function button of a display to open a light scene page. Otherwise it is not possible to set up the light scene values on the panel at a later time. Navigation between the light scene pages is made possible by the scroll bar, assuming it is shown.

Adding light scene groups

Then the light scene groups must be added to the project planning. Four screen pages are available in the ETS plug-in under the node "Light scenes -> Groups". Up to eight light scene groups can be added to each of these four pages to control various KNX / EIB actuator groups by clicking the right mousebutton. For additional clarity, these light scene groups should be given clear designations straight after adding. These designations cannot be modified on the panel after commissioning.

In the ETS plug-in, there is a "light scene object" available for each light scene group. A group address must be linked to each light scene object, which must also be linked to actuators on the KNX/EIB page. In the plug-in, the data format of each light scene object can either be specified as "1 bit (switching)" or, alternatively, as "1 byte (value)".

- i** During panel operation, the four screen pages of the light scene groups can only be reached via the light scene pages, by changing the light scene on the light scene page (function button 2 "Change light scene"). Therefore it is necessary to configure at least one function button of a display to open a light scene page. Otherwise it is not possible to set up the light scene values on the panel at a later time.
Navigation between the light scene pages or the light scene group is made possible by the scroll bar, assuming it is configured to be shown.

4.2.4.5.2 Specifying light scene values

When all the light scenes and light scene groups have been created in the ETS plug-in and the group addresses have been assigned to the objects, commissioning can take place. During first commissioning (programming operation by the ETS or the plug-in) the light scene names, the groups and the values saved in the panel must be overwritten (see chapter 4.2.4.1.4. Download behaviour).

After commissioning, the light scene values can be edited directly on the panel - either by the installation engineer or the panel operator. In addition the light scene names can be modified at any time. The light scenes (light scene text) and light scene groups (light scene values) can be edited on the light scene pages (figure 22). The light scene pages are system pages, which can be opened using the Open page command.

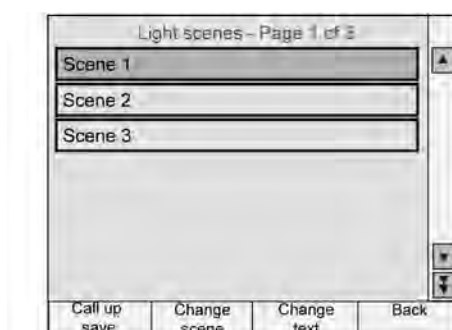

Figure 22: Light scene page

The function buttons of the light scene pages can be used to open the following functions...

- Button 1 "Open / Save": pressing the button briefly opens the currently highlighted scene. Pressing it for longer (longer than 5 seconds) saves new values for the current light scene.
- Button 2 "Change light scene": opens the light scene groups, in order to edit light scene values (see below).
- Button 3 "Change text": allows modification of the predefined light scene designations in the ETS plug-in (light scene text) and thus adjustment to the requirements of the user. The light scene text can be entered using the on-screen keyboard.
- Button 4 "Back": return to the page from which the light scene page was opened.

The light scene values (switching or value) can be edited on the light scene group page. The light scene group pages (figure 23) are opened by pressing button 2 "Change scene" on the light scene pages.

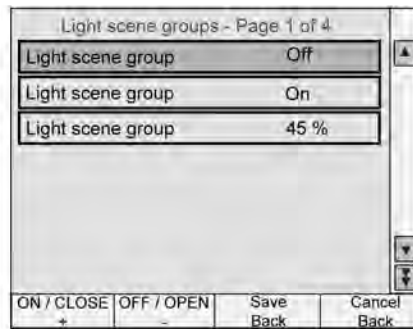

Figure 23: Light scene groups page

The function buttons of the light scene groups pages can be used to open the following functions...

- Button 1 "On / Close +": changes the light scene values of the currently highlight light scene group. Depending on the data format (1 bit or 1 byte) either a light scene switching command can be set to "ON" / "Close" or a light scene value specified (in steps of + 1%).
 - Button 2 "Off / Open -": changes the light scene values of the currently highlight light scene group. Depending on the data format (1 bit or 1 byte) either a light scene switching command can be set to "OFF" / "Open" or a light scene value specified (in steps of - 1%).
 - Button 3 "Save / Back": saves all the light scene values and returns to the light scenes page.
 - Button 4 "Cancel / Back": rejects the changes to the light scene values and returns to the light scenes page. The old light scene values are maintained.
- i** Buttons 1 and 2 also all the specification of the status "unchanged" for light scene switching commands (for data format 1 bit). In this case, when the light scene is opened, the appropriate group remains unchanged (no telegram is transmitted via the light scene object). Similarly no read telegram is transmitted when the light scene is saved.
- i** The light scene values set on the panel are saved in the non-volatile memory and are thus not lost if the power supply fails. During programming with the ETS or the plug-in, it can specified whether the light scene texts and light scene values are to be overwritten on the panel (see chapter 4.2.4.1.4. Download behaviour).

4.2.4.6 Timer switch function

Timer switch

The panel possesses an integrated weekly timer switch with up to 16 channels, which are split into two timer switch pages of eight channels. The timer switch pages are predefined as system pages can be jumped to by pressing a function button to open a page.

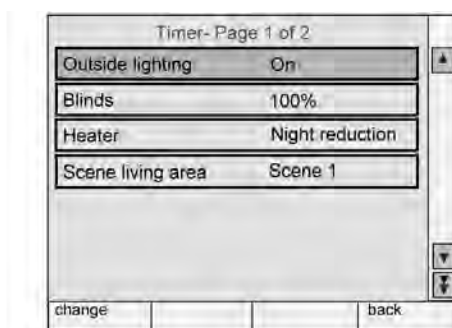

Figure 24: Timer switch page

Eight switching times can be assigned to each channel. The weekdays can be freely selected for each switching time. The switching times can be programmed as a specification in the ETS plug-in or directly on the panel at any time after commissioning using the timer switch pages. In addition, a random function and an astro function for time-dependent lighting or shading control can be activated on each timer switch channel.

The timer switch is controlled by the internal real time clock of the panel. If the 230 V power supply fails, the internal clock runs on for approx. 24 hours. When the power supply returns, the timer switch checks to see if switching times were programmed for this period. In this case, the last programmed command is carried out for the affected channels.

When the internal clock is resynchronised, a distinction is to be made between two cases...

- The clock is moved back to a time before an already executed switching time. In this case, the programmed command is executed again when the switching time occurs.
- The clock is moved forward to a time after an as yet unexecuted switching time. In this case, the last programmed command of the channel is carried out.

4.2.4.6.1 Creating timer switch channels

When the timer switch channels are created, a display element is generated on the appropriate timer switch page. A timer switch channel is added by clicking the right mousebutton in the parameter node "Timer switch -> Timer switch page..."

As with the display elements on the planned used pages, each timer switch channel also possesses a designation, which only appears in the tree structure of the ETS plug-in and a text which is displayed on the screen. This text can be positioned horizontally in the display element.

One of four functions can be assigned to each timer switch channel using the "Function" parameter...

- Switching
- Value
- Light scene
- Operating mode switch

This allows lighting to be switched at a switching time, a blind to be moved, a light scene to be opened or the mode of a room temperature controlled to be influenced. The additional setting options and communications objects of the named switching channel function primarily correspond to those of the display elements (see chapter 4.2.4.2.2. Display elements).

According to the selected switching channel, four function buttons can also be shown on the bottom edge of the screen on each of the two timer switch pages. The following settings can be selected for these function buttons...

- "No function" (function button inactive)
- "Change timer switch setting for channel". This function is the default setting for button 1 and can only be used in each channel.
- "Open page". This function is the default setting for button 4. There can be either a jump back or a jump to any screen page created by the user. Other system pages are not jumped to at this point.
- Execution of a manual operating function, depending on the type of the timer switch channel.

4.2.4.6.2 Setting switching times

There are two options when setting the switching times. The up to eight switching times of a switching channel can be preset in the ETS plug-in. Additionally, or alternatively, it is possible to set each switching time directly on the panel after commissioning.

Presetting in the ETS plug-in

If a timer switch channel is selected in the tree structure, the (up to eight) switching times of the channel can be edited in the parameter branch "Switching times". For this, any parameter field of a switching time should be selected with the mouse or the keyboard and the "..." button to open the "Change switching time" window (figure 25).

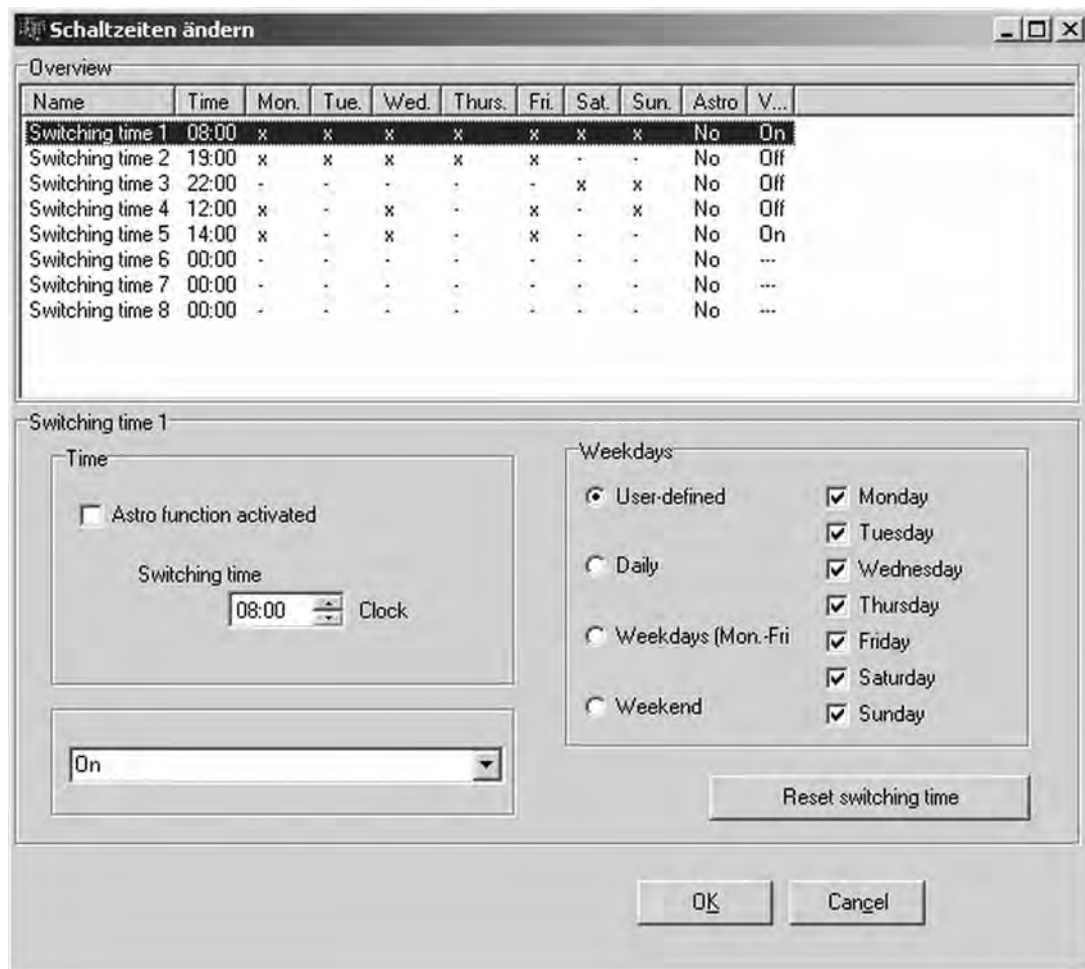

Figure 25: Window to change the switching times

The following parameters are displayed and the configuration options offered...

- "Clock" list box: displays the switching time. In the parameter area "Time" of the window, the switching time can be set individually in 24 hours format.
- List boxes for the weekdays: display the weekday, upon which the switching time is to be executed. The weekdays can be configured individually in the parameter area of the same name. To simplify configuration, the weekday intervals (daily, on weekdays, weekends) are predefined.
- "Astro" list box: display of whether the corresponding astro function is activated for the switching time (see chapter 4.2.4.6.3. Astro and random function). The astro function can be activated individually for each switching time. For this, select the "Astro function activated" checkbox in the "Time" parameter box.

- "Value" list box: display of the telegram command to be transmitted or the light scene to be opened when the switching time is processed. The value of a switching time can be set in the selection box on the bottom left in the "Change switching times" window. The setting options in the selection box is adjusted automatically by the plug-in, depending on the timer switch channel function set in the ETS plug-in.
- "Reset switching time" button: when pressed, completely resets the switching time selecting i the list box (switching time "00:00", no weekdays, no astro, no value)

- i** For the switching times preset for the plug-in to be correctly transferred to the panel during the programming operation, the parameter "Overwrite all switching times of the timer switch" in the top parameter node of the plug-in is set to "Yes" (see chapter 4.2.4.1.4. Download behaviour). Before first commissioning of the panel, set this parameter to "Yes", if a switching time specification is configured in the plug-in. Otherwise, the switching times preset in the plug-in are not transferred to the panel.
If the parameter is configured to "Yes", the switching times changed directly on the panel are always overwritten during programming operations.
- i** The switching times preset by the plug-in and loaded into the device can be changed at any time directly on the panel.
- i** The switching times preset in the plug-in may only be entered in 24 hour format, irrespective of the configured display format of the time.

Setting on the panel:

If the panel was commissioned with a programming operation, then the switching times of the timer switch channels can be edited directly. To set a switching time, select the required channel on the timer switch page and then press the button for the "Change timer switch setting for channel" function (default button 1: "Change") as assigned by the project planner. This opens the screen page with an overview of the currently defined switching times for this channel (figure 26).

Outside lighting							
08:00	M	T	W	T	F	S S	On
19:00	M	T	W	T	F	_ _	Off
22:00	_	_	_	_	S	S	Off
12:00	M	_	W	_	F	_ _	Off
04:00	M	_	W	_	F	_ _	On
--	M	T	W	T	F	S S	Off
--	M	T	W	T	F	S S	Off
--	M	T	W	T	F	S S	Off

change Save Cancel

Figure 26: Overview of the switching times of a timer switch channel

On the new screen page, the time, the weekdays and, optionally, the astro function and the value to be sent can then be set (figure 27). The individual fields have the same functions as described above under "Presetting in the ETS plug-in".

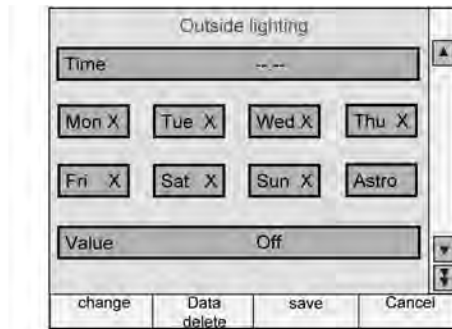

Figure 27: Window for changing the parameters of a switching time

- i** The switching times changed on the panel are saved in the non-volatile memory of the device. During a programming operation, the switching times changed and saved on site can be overwritten with the default switching times in the plug-in. For this, the parameter "Delete all the switching times of the timer switch" in the top parameter node of the plug-in must be set to "Yes" (see chapter 4.2.4.1.4. Download behaviour). If this parameter is configured to "No", then the last switching times set on the panel remain unchanged during a programming operation.
- i** The switching times settable directly on the panel in the plug-in may only be edited in 24 hour format on the on-screen numeric keypad, irrespective of the configured display format of the time. If the time is to be display in 12 hour format, then the panel automatically converts the edited time. The time display format is always configured in the top parameter node of the ETS plug-in.

4.2.4.6.3 Astro and random function

Astro function

The astro function allows the control of a lighting or shading system depending on sunrise and sunset and a limit time. The astro function can be activated separately for each switching time. The panel calculates the time of the sunrise and sunset (astro time) automatically according to the local geographic position (geographic co-ordinates). The setting of the co-ordinates is the precondition for correct functioning and is carried out in the "Timer switch" parameter node in the "Location data" parameter group and applies in the same way to all the timer switch channels. A special dialog in the ETS plug-in simplifies the determination and configuration of the geographic location co-ordinates.

When the astro function is activated, the time set in the ETS plug-in or directly on the panel as the limit time. Whether the limit time affects sunrise or sunset is evaluated by the device according to the set time. Times between 00:00 and 11:59 are evaluated as sunrise and times between 12:00 and 23:59 as sunset.

An astro function usually affects lighting (e.g. exterior lighting) or shading (e.g. roller shutters). The behaviour of the panel when processing the astro switching times varies according to these applications. The parameter "Channel affects" in the parameter node of a timer switch channel defines the astro behaviour - irrespective of the data format of the communication object of the channel - as follows...

- "Lighting" setting:
 - Sunrise (switching times 0:00 - 11:59): if sunrise occurs before the set time (for example in the summer months), then, at sunrise, the switching time command (e.g. external lighting OFF) is sent to the bus. If sunrise occurs later (for example during the winter months), then the switching time command is sent to the bus at the set time at the latest. When a switching time is set, the appropriate time is overwritten with "At the latest" in the ETS plug-in.
 - Sunset (switching times 12:00 - 23:59): if sunset occurs after the set time (for example in the summer months), then the switching time command (e.g. external lighting ON) is sent to the bus at sunset. If sunset occurs earlier (for example during the winter months), then the switching time command is sent to the bus at the set time at the latest. When a switching time is set, the appropriate time is overwritten with "Not before" in the ETS plug-in.

 - "Shading" setting:
 - Sunrise (switching times 00:00 - 11:59): if sunrise occurs after the set time (for example in the winter months), then the switching time command (e.g. roller shutters UP) is only sent to the bus at sunrise. If sunrise occurs earlier (for example during the summer months), then the switching time command is sent to the bus at the set time at the latest. When a switching time is set, the appropriate time is overwritten with "Not before" in the ETS plug-in.
 - Sunset (switching times 12:00 - 23:59): if sunset occurs before the set time (for example in the winter months), then the switching time command (e.g. roller shutter DOWN) is sent directly to the bus at sunset. If sunset occurs later (for example during the summer months), then the switching time command is sent to the bus at the set time at the latest. When a switching time is set, the appropriate time is overwritten with "At the latest" in the ETS plug-in.
- i** Depending on the geographic position of the location, the astro times for sunrise and sunset will vary by several hours. If a switching time with an active astro function affects another switching time of the timer switch channel, then the astro function is not executed. Example: a switching time is set to 17:00, astro function active (seasonal sunset between 16:00 and 22:00), an additional switching time is set to 19:00 -> In this case, the second time (19:00) would be affected by the astro function, meaning that it would be deactivated for the affected switching time(s). The same would apply, if both switching times in the example had the astro function active.

- i** In 12 hour time display format, the switching times for sunrise and sunset apply in the same way. Times between 12:00 AM and 11:59 AM are evaluated as sunrise and times between 12:00 PM and 11:59 PM as sunset.

Random function

The switching times of a channel can be triggered offset in a set random period. The random function can be activated separately for each timer switch channel and affects all the switching times of the appropriate channel.

Each day at 0:00, the panel calculates a time offset individually and randomly for each switching time, by which a switching time is brought forward minute-by-minute (-) or is set back (+). The maximum time offset between the set switching time and the actual time of the version can be configured in the ETS plug-in for each timer switch channel using the parameter "Max. time offset +/-". This allows time offsets of between 1 and 30 minutes. The setting "0" for the time offset completely deactivates the random function for the timer switch channel. The panel randomly determines a time from the configured maximum time offset and adds this time either to the set switching time or, alternatively, subtracts it from the switching time.

- i** It is not possible to transfer the switching times into the previous or next day using the time offset, i.e. the random function does not extend beyond the ends of days. If a randomly calculated time offset of a switching time goes beyond the end of a day, then the random function for the affected switching time is not executed. The same applies when the random time offset affects other switching times in the timer switch channel. When using the random function to specify the switching times of a channel, care should be taken that the individual switching times are apart by at least +/- the maximum time offset, as configured in the ETS plug-in.
Example: maximum time offset = +/- 30 minutes, one switching time set to 11:00, random function active -> other switching times of the channel may be between 0:00 ... 10:30 and 11:30 ... 23:59 (and in the same way for the 12 hour display format). The same applies to additional switching times with a random function.
- i** If, in addition to the random function, an astro function is also activated, then the following prioritisation applies to the calculation of the switching time:
 1. Astro time complying with "Not before" / "At the latest"
 2. The random time is added or subtracted to the time calculated under 1.

4.2.4.7 Timers

The panel has the ability to create up to 40 timers. A timer allows the filtering of incoming 1 bit telegrams of a communication object, the delaying of switching statuses according to the switching flank and then forwarding via an output communication object. Both internal and external group addresses can be linked to the objects.

To add a timer to the project planning, the parameter node "Timers" should be selected in the tree structure of the ETS plug-on and executed by clicking the right mousebutton on the command "Add timer". For added clarity, each timer is given a designation in the ETS plug-in, which can be changed by the project planer using the parameter of the same name.

A timer consists of an input object, an output object and an optional blocking object. In the device software, the timer acts like a sluice with time delay and filter function. Depending on the value of the blocking object and the parameters, the value of the input object is either forwarded to the output object or is disabled (figure 28).

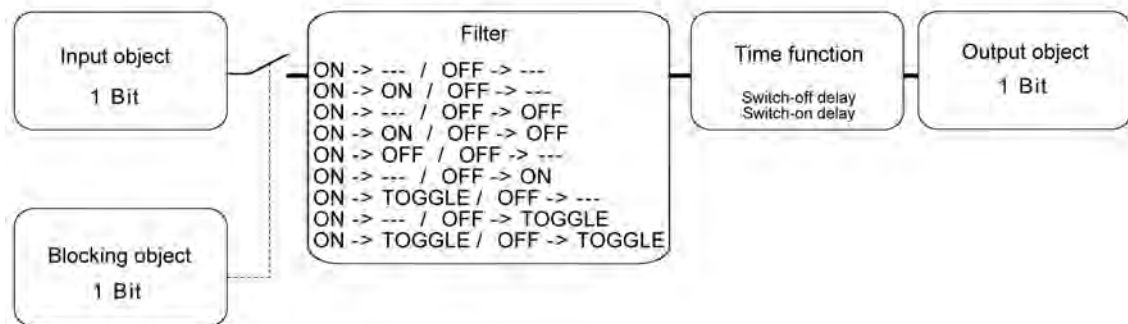

Figure 28: Elements of a timer

The blocking object is a 1 bit communication object, whose behaviour (block on 0, block on 1) can be set in the parameter group of a timer. If, during a block, the input value is changed, then the output can automatically send a telegram, as soon as the block is lifted, or it waits until the next input telegram.

4.2.4.8 Logical links

The panel has the ability to create up to 80 logical link functions. To add a link to the project planning, the parameter node "Logic -> Links" should be selected in the tree structure of the ETS plug-on and executed by clicking the right mousebutton on the command "Logic gate". For added clarity, each logic gate is given a designation in the ETS plug-in, which can be changed by the project planner using the parameter of the same name.

A logic gate consists of up to eight 1 bit input objects (E1...E8), which can be added by clicking the right mousebutton, a 1 bit output object (A) and an option blocking object. For each logic gate, the parameter "Link type" can be used to select one of the logical functions AND, OR, exclusive OR or AND with return, which is then also shown in the tree structure (figure 29). In addition, each input and the output can be evaluated normally or inverted.

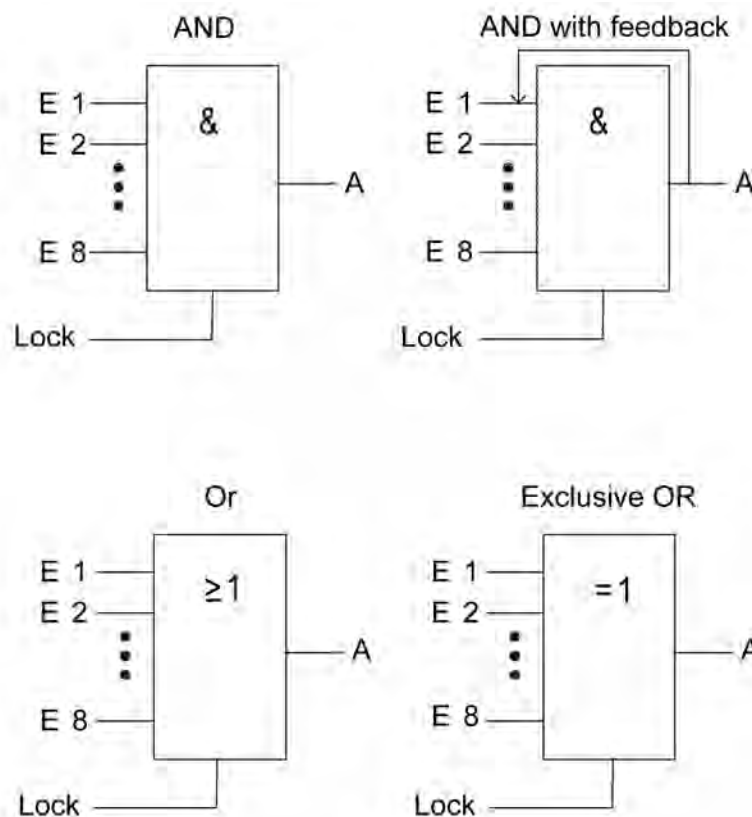

Figure 29: Link functions

- i** With an "AND with return" the value of the input is fed back internally to input 1. The result of this is that the output can only be given the value "1" again if input 1 is set to "1" after the value "1" is also present on all of the other inputs. As soon as one of the other inputs is given the value "0", the output and thus input 1 are set to "0". If the return is carried out with an inverted output, the inversion is only processed after the return.

Example: One application for this type of logic operation a light that should only be switched on manually after twilight falls. Here the pushbutton is linked to input 1 and the limiting value of the twilight sensor is linked to input 2. After the twilight sensor has set input 2 to "1", the pushbutton on input 1 can be used to switch on the light. If the user forgets to switch the light off again manually, when daylight comes the feedback ensures that input 1 is reset internally to "0". Without this feedback the light would be switched on again automatically at the next twilight.

Taking an example of three inputs, the following output statuses would be produced without inversion of the input signals or the output, according to the set link function...

Input 1	Input 2	Input 3	Output AND	Output OR	Output EX OR	Output AND with feedback
0	0	0	0	0	0	0
0	0	1	0	1	1	0
0	1	0	0	1	1	0
0	1	1	0	1	0	0
1	0	0	0	1	1	0 *)
1	0	1	0	1	0	0 *)
1	1	0	0	1	0	0 *)
1	1	1	1	1	1	1

Table 8: output status of the logical link functions

*) : Input 1 is automatically set to "0" here.

The transmission behaviours of the output of a gate can be influenced in different ways...

- The parameter "Transmit on" of a gate together with the "Change the output" setting can reduce the bus load. In this case, telegrams are only transmitted when the logical status of the output changes. If, for example, the result of the link is time-monitored in a roller shutter actuator, it may be advisable to have the output transmit a telegram on each input event ("Each input event" setting).
- The gate can be disabled or enabled using the optional 1 bit blocking object. It is possible to set for which object value the block is active. The transmission behaviour of the logic gate can be defined after the block has been enabled. If, during a block, the input value is changed, then the output can automatically send a telegram, as soon as the block is lifted, or the gate waits until the next input telegram.
- The output also possesses a filter function. This sets whether it can transmit each output value or whether it can only send "1" telegrams or only "0" telegrams.

4.2.4.9 Multiplexer

The panel has the ability to create up to 12 multiplexer functions. To add a multiplexer to the project planning, the parameter node "Logic -> Multiplexer" should be selected in the tree structure of the ETS plug-on and executed by clicking the right mousebutton on the command "Add multiplexer". For added clarity, each multiplexer is given a designation in the ETS plug-in, which can be changed by the project planer using the parameter of the same name.

A multiplexer forwards the value of an input object to one of two or one of four outputs. The output used depends on the status of the control input (one to two) or one of the two control inputs (one to four). Each multiplexer of the panel can contain up to three channels, which can be controlled by the same control inputs and added by clicking the right mousebutton. Within a channel, the input and the outputs have the same object type. The following data formats are support, and can be configured using the parameter "Object type input / outputs" for each channel: DPT 1,001 (switching, 1 bit), DPT 3,007 (dimming, 4 bit), DPT 9,001 ... 9,0021 (value, 2 byte), DPT 5,001 ... 5,004 (rel. value, 1 byte), DPT 14,000 ... 14,079 (IEEE float, 4 byte), DPT 7,001 / 8,001 (counter, 2 byte), DPT 12,001 / 13,001 (counter, 4 byte), DPT 16,001 / 16,002 (ASCII characters, 1 byte), DPT 5,010 (counter, 1 byte).

The following truth tables and figure describe the internal function of the multiplexers according to the function "1 to 2 multiplexer" or "1 to 4 multiplexer".

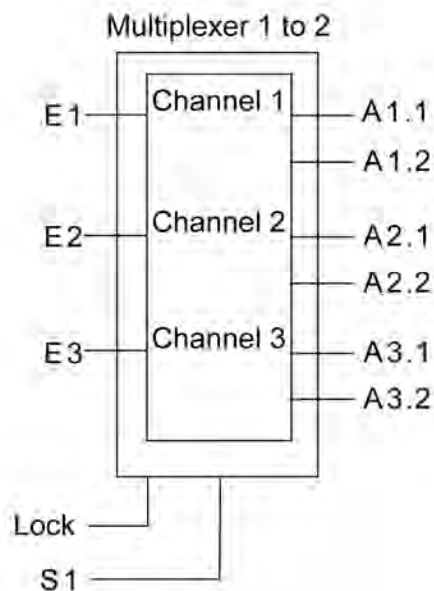

Figure 30: Multiplexer "1 to 2"

Control input 1	Forwarding to
0	Output 1
1	Output 2

Table 9: selection of the output by control input for multiplexer "1 to 2"

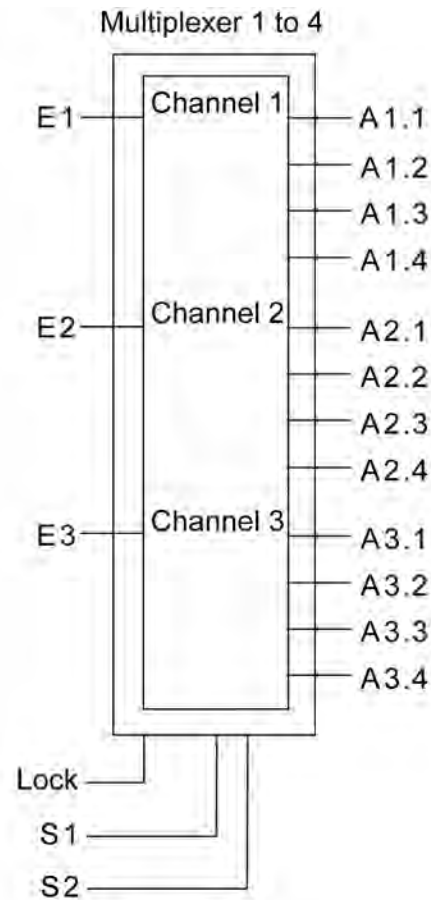

Figure 31: Multiplexer "1 to 4"

Control input 2	Control input 1	Forwarding to
0	0	Output 1
0	1	Output 2
1	0	Output 3
1	1	Output 4

Table 10: selection of the output by control inputs for multiplexer "1 to 4"

When the control inputs change, the outputs do not transmit telegrams. Only when an input object receives a new value is it forwarded to the current output. The multiplexer can be blocked or enabled using the optional blocking object. It is possible to set for which object value the block is active. The behaviour can be defined after the block has been enabled. If the block is lifted, the output can automatically transmit a telegram or the multiplexer waits until the next input telegram.

4.2.4.10 Datalogger

Introduction

The datalogger offers the option of recording KNX/EIB data - for example temperature values, command values, lighting status, etc. - in various formats in the device memory and to show them in a value-time diagram on the display. In so doing, the data telegrams received from the KNX/EIB are 'compressed' at set intervals and saved in a datalogger channel of the panel as minimum, maximum and average values and can be displayed as necessary.

The datalogger is primarily subdivided into the function modules "Datalogger recording" and "Datalogger display".

4.2.4.10.1 Datalogger recording

The KNX/EIB data are saved to a datalogger channel. A maximum of 20 datalogger channels can be inserted in the device project planning of the panel. New channels can be added by clicking the right mousebutton in the "Datalogger" parameter node in the plug-in. Each channel can be given a designation, so that it is easier to distinguish between the individual channels during later project planning work.

Communication object and data format:

Each datalogger channel possesses a communication object. The data format of this object can be specified using the "Data type" parameter in the parameter group of a channel. The following data formats are available...

DPT 9,001 ... 9,021 (2 byte value), DPT 5,001 ... 5,004 (1 byte value),

DPT 14,000 ... 14,079 (4 byte float value),

DPT 8,001 (2 byte numeric value with plus/minus symbol), DPT 7,001 (2 byte numeric value),

DPT 13,001 (4 byte numeric value with plus/minus symbol), DPT 12,001 (4 byte numeric value),

DPT 6,010 (1 byte numeric value with plus/minus icon), 5,010 (1 byte numeric value).

Recording period:

Telegrams reaching the communication object are divided up within a recording period to various time intervals and assigned to them. At the end of each time period, the telegrams received are evaluated and a minimum and maximum interval value determined. In addition, an average value is calculated and saved.

The smallest and largest values are evaluated as the minimum and maximum values. To calculate the average, the recorded values are totalled and divided by the number of recorded values. If, within a time period, only one telegram data value was received, then the minimum value = maximum value = average value.

The recording period specifies the visible time window of the value-time diagram (scaling of the X axis) in the on-screen display (see chapter 4.2.4.10.2. Datalogger display).

Using the parameter of the same name, the recording period can be configured separately in the datalogger channel in the ETS plug-in. The following recording periods can be configured with the appropriate time periods...

- "Hour (60 intervals of 1 minute)":
The recording period is set to one hour. Within this hour, 60 time intervals are formed, each 1 minute in length, meaning that the incoming telegrams are evaluated 60 times and the results saved.

- "Day (24 intervals of 1 hour)":
The recording period is set to one day. Within this day, 24 time intervals are formed, each 1 hour in length, meaning that the incoming telegrams are evaluated 24 times and the results saved.

- "Week (7 intervals of 1 day)":
The recording period is set to one week. Within this week, 7 time intervals are formed, each 1 day in length, meaning that the incoming telegrams are evaluated 7 times and the results saved.

- "Month (31 intervals of 1 day)":
The recording period is set to one month. Within this month, 31 time intervals are formed, each 1 day in length, meaning that the incoming telegrams are evaluated 31 times and the results saved.

- "Year 1 (12 intervals of 1 month)":
The recording period is set to one year. Within this year, 12 time intervals are formed, each 1 month in length, meaning that the incoming telegrams are evaluated 12 times and the results saved.

- "Year 2 (52 intervals of 1 week)":
The recording period is set to one year. Within this year, 52 time intervals are formed, each 1 week in length, meaning that the incoming telegrams are evaluated 52 times and the results saved.

- i** If, within a period of time, no telegram could be received and evaluated, then the corresponding interval is considered "invalid". The characteristic curve is thus interrupted in the value-time diagram of the on-screen display.
To prevent such behaviour, the data value sources - such as the room temperature controller, weather stations, etc. - should transmit the telegram data value cyclically to the bus with a cycle time which is considerably shorter than the set time period. At least two telegram data values should be received in a time interval. The evaluation of the minimum, maximum and average values becomes more accurate, the more telegrams are received in the time period.

Cyclic polling:

During data recording, regular incoming telegrams (ValueWrite) or value responses or a cyclic poll (ValueResponse) can be evaluated. Cyclical polling of the object value can be activated separately for each datalogger channel.

With activated cyclic polling, the panel transmits a value read telegram (ValueRead) to the bus regularly, after a period of time has elapsed. The data source must then return a value response telegram (ValueResponse) to the panel. The "Read" flag must be set on the transmitting object of the data source for this to function correctly.

The time period of a cyclic poll can be configured in the ETS plug-in. The setting options automatically align themselves to the configured recording period and the resulting time periods. This ensures that at least one data value is requested within a time period.

- i** The panel makes a distinction between normal telegrams (ValueWrite) and value response telegrams. With activated cyclic polling, the minimum, maximum and average values are added to the value responses. In this case, additional spontaneous telegrams are only given the maximum and minimum values.

- i** Cyclic polling is preferable for even average formation.

Saving the data:

When the day changes (jump to 0:00), the recorded time period data of the last recording period of all the data channels is backed up in the non-volatile flash memory of the panel. Only the data of all the completed time periods is taken into account. Temporary data for current, unfinished periods is not taken into account on saving to the flash data memory.

After a device reset (power failure or programming operation), the data backed up in the flash memory are rewritten to the normal memory of the panel and are thus available again to the datalogger display.

It should always be noticed that all the data of any day between 0:00 and the current time will not be available after a reset as it is not transferred to the flash data memory before the reset. This property should especially be taken into account with the short recording periods "Hour" and "Day" as, in these cases, whole recording periods could be lost if a device reset takes place without successful saving.

- i** On programming the device firmware, the entire flash data memory is deleted and overwritten. In this case the saved data of the datalogger no longer exists. This matter should be particularly taken into account, if, for example, after an update of the ETS plug-in, the device firmware is also automatically updated during a new programming operation.

Differential calculation:

If the data source is a counter (e.g. electricity meter, people counter, etc.), data recording can be switched to differential calculation. In so doing, a differential between the last received value and the last value of the previous period is calculated and stored as a display data value in the panel. No calculation of minimum, maximum or average values take place. The calculated data value differentials then, in the case of an electricity meter, directly represent the consumed units of power within a recording period (e.g. month or year).

To ensure that the differential calculation produces useful display values, only those counter values should be used as data which are counted in one direction (either increasing or decreasing). In addition, differential calculation with data values not from counters is usually meaningless and thus impracticable. Therefore, differential calculation should only be used for data channels which have "Counter" configured as the object data type.

After a device reset (power failure, programming operation), the differential calculation starts at a specified starting value. This is required to initialise the differential formation, so that a differential value can be calculated in the first recording period after a reset. This means that, in addition, there can be an adjustment to defined basic counter levels - for example after the installation of a new electricity meter.

The system project planner must enter the starting value in the parameter of the same name in the ETS plug-in. This means that it is stored statically in the device project planning. A distinction must be made between two different cases:

If a value is entered in the parameter box (standard value = "0"), the value then evaluates the last data value of the first time period after the reset directly and then shows the difference to the starting value in the display diagram (see chapter 4.2.4.10.2. Datalogger display).

Alternatively, the parameter field of the start value in the ETS plug-in can be left empty. In this case, the panel automatically evaluates the first data value received as the start value. This value does not appear in the data display. Only the differential values calculated after this (last value of 1st period <-> last value of 2nd period, etc.) are transferred to the display as display values.

- i** With a set cyclic poll of the channel object, only the response telegrams (ValueResponse) of the data source are used to record the differential data. Additional spontaneous telegrams (ValueWrite) are not taken into account in a differential evaluation.

e-mail at datalogger:

If the panel is connected to a network via an Ethernet connection and an e-mail mailbox is configured to send e-mail messages, the data values recorded by a datalogger channel can be sent cyclically by e-mail. In this case, the panel prepares the data in a CSV file and sends it to a specified recipient in a standard e-mail. Both the e-mail function and the recipient address can be configured in the ETS plug-in in the parameter group of a datalogger channel.

The e-mail is sent automatically each time the configured recording period has elapsed. The data forwarded by e-mail thus take only the data values of one recording period into account.

- i** Irrespective of the sending of the e-mail message, the PC Client software can also read out and archive the data values of the datalogger (see chapter 4.3.1. Introduction, installation and program start).

4.2.4.10.2 Datalogger display

The data recorded in a datalogger channel is displayed as a display function of a display element, whereby the data values are shown as a continuous characteristic curve in a value-time diagram.

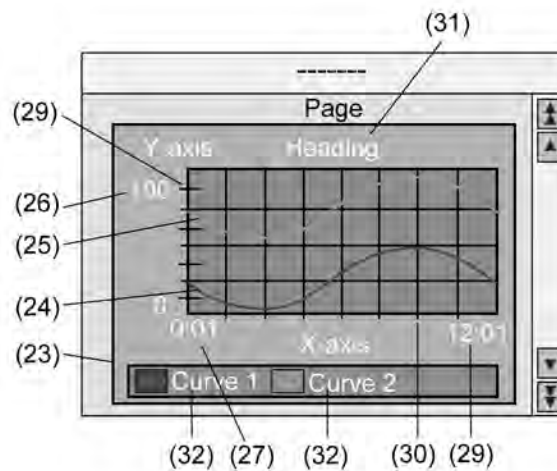

Figure 32: Datalogger display in a display element as a value-time diagram

To configure a datalogger display, a display element (23) must be first added to a page created in the ETS plug-in by the project planner. This element should then be configured as a "datalogger display" (see chapter 4.2.4.2.2. Display elements).

Up to two datalogger channels can be displayed as curves (24) & (25) in a diagram (display element). The curves to be displayed are selected using the parameters "Curve 1: datalogger channel" and "Curve 2: datalogger channel". Within a datalogger display element, only those channels with the same recording periods can be displayed.

- i** The diagram size is directly affected by the size of the display element. Here, the minimum size should be maintained, according to the information shown and the scaling of the axes. If the minimum size is undershot, then it will not be possible to show the diagram on the panel display. In this case, the appropriate display element is filled with a cross.

The Y axis (26) can be scaled dynamically according to the values to be displayed (specified by minimum and maximum values of the recording period) or, alternatively, can be permanently configured in a value range. If the scaling of the Y axis is fixed, and there is a data value outside the specified minimum or maximum limits, then the data value curve is drawn in vertically upwards or downwards from the two neighbouring data points.

The scaling of the X axis is automatically specified by the configured recording period and the resulting time intervals of a datalogger channel. At the bottom left side of the X axis, the diagram always displays the time of the measured value of the first successfully evaluated interval of the previous recording period (27). The data value curve begins at this time. The bottom right item of the X axis displays the time at which the measured value of the last interval of the recording period was recorded (29). If only one interval was recorded, then the two displayed times are the same.

The formatting of the date and time is specified in the top parameter node of the plug-in using the "Date display format" and "Time display format" parameters. The data - partially with special formatting - is only displayed for recording periods lasting several days, weeks or months. The time is only displayed on the X axis when the recording period is set to "Hour" or "Day". Both axes can be given subdivisions (29) and additional lines (30) to simplify the legibility of the diagrams.

In the parameter group of the datalogger display, it is possible to configure a heading for the diagram (31) and names for each curve (32). In addition, "reinforcement" and "offset" can be

added to the measured values of a channel to allow the option of modification of the desired measured value ranges in the diagram.

In addition, the datalogger display parameters can be used to specify which recorded data value is to be displayed in the diagram as the "curve type" (maximum value, minimum value or average value). When a datalogger channel is displayed with differentials in the data value recording, it is not possible to select the curve type as there can only be one differential value displayed for each interval.

A maximum of four display elements can be configured on a screen page as datalogger displays. A total of 50 datalogger displays can be created in the panel and distributed to different pages.

- i** Within a diagram, the characteristic curve created from the data values runs from right to level parallel to the time axis.
- i** If, within a period of time, no telegram could be received and evaluated, then the corresponding interval is considered "invalid". The characteristic curve is thus interrupted in the value-time diagram of the on-screen display.
- i** In a diagram, the values of a datalogger channel are displayed, without reformatting, in the way that they are receive in the data telegram from the bus, providing that no reinforcement or offset is specified in the configuration of the curve. As a result, a data value, for example, received in the format DPT 5,001 (1 byte value) in a value range of 0...255 can be displayed in the diagram. If, in this example, percentage values should be displayed (e.g. command values), the data values can be reformatted by the reinforcement. In such a case, a 1 byte data value (0...255) with a reinforcement of "0.392" can be converted to a percentage data value (0...100 %). This reinforcement should then be entered in the parameter of the same name of the affected curve in the ETS plug-in. An offset causes a shift of the appropriate curve upwards on the Y axis (positive offset) or downwards (negative offset).

4.2.4.11 Presence simulation

Introduction

The presence simulation can give those outside the impression that a house or office block is occupied, especially when there is no-one inside. The owners or operating personnel can record any simulations, for example for lighting or shading, over periods of time and play them back when they are not there.

The recording records KNX/EIB telegrams in the 1 bit and 1 byte data formats and temporarily saves them with time and weekday information. On playing back, the previously saved telegram sequence can either be played back with accurate times or, alternatively, with accurate times and weekdays.

The presence simulation is operated on the system page of the same name in the panel. This system page can be jumped to using the Open page function button. Operation of the presence simulation makes a key distinction between the recording and the playing back of a telegram sequence.

4.2.4.11.1 Recording a telegram sequence

Select functions

The presence simulation records telegrams received from the KNX/EIB. For this, the project planner must create special recording objects, which are independent from the rest of the panel project planning, in the ETS plug-in. A recording object can be added by clicking the right mousebutton in the "Presence simulation" parameter node. Up to 32 objects can be created in this way.

In the parameter group of a recording object, a clear designation can be assigned (e.g. "Seating group light" or "Roller shutter, living room"), which can then be read off on the panel by the operator. In addition, the required data format of the recording object must be configured. The two formats "DPT 1,001 (i bit switching)" and "DPT 5,001...5,004 (1 byte value)" are available. Additional parameter configuration are not required in the ETS plug-in for the presence simulation.

Before the presence simulation can be used, the operator must record a sequence of telegrams on the panel. For this, the operator must switch to the "Presence simulation" system page (figure 33).

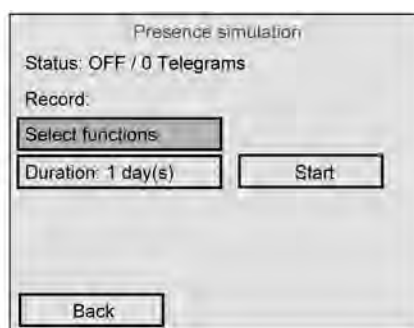

Figure 33: System page of the presence simulation

In the first step, the functions must be selected which are to be included in the presence simulation. The functions are defined as the recording objects, previously created in the device project planning and linked with group addresses, and the building units controlled by them. The term "Functions" is used instead of "Objects" on the user control interface, as the switching or value telegrams configured in the ETS project execute specific functions, i.e. switching lights or controlling a shading situation.

Pressing the "Select functions" button on the system page of the presence simulation (figure 33) opens the page "Presence simulation channel selection" (figure 34).

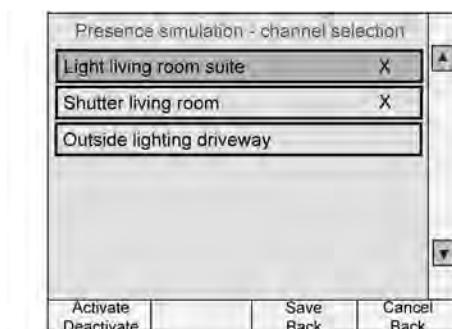

Figure 34: Page for selecting the channel of the presence simulation.

At this point, the user sees the 32 functions (recording objects) created in the ETS plug-in. The user can now select up to 15 functions and include them in the presence simulation. The selections are made directly by tapping the appropriate function button on the screen. A function selected for the presence simulation is indicated by an "X" in the function button behind the function designation. Tapping the function button again deselects the function. In the same way, the state "Selected" or "Not selected" can be influenced using the "Activate / Deactivate" button.

After pressing the "Save back" button, the selection is saved in the panel and the panel jumps back to the system page of the presence simulation. Pressing the "Cancel back" button simply causes a jump back to the presence simulation page without saving the user configuration.

By changing the channel selection, the user can, at any time, change the functions included in the presence simulation and, if the situation requires, adapt it to special requirements.

- i** The channel selection is only saved temporarily in the RAM of the panel, meaning that a new selection is required (every function deactivated) and resaving is required after a power failure or a programming operation.
- i** If the function selection is changed and resaved after a simulation has been recorded, then the previous recording is deleted. The operator must then record a new simulation (see next section).

Recording a telegram sequence

After the operator has selected the functions of the presence simulation, the telegram sequence can be recorded. For this, the operator must first specify a maximum recording period in days. Usually, a simulation recording takes place independently in the background. The length of the recording period can be used to specify when the simulation recording stops automatically after starting. Independently of this, a recording can also be stopped manually at any time (see below).

The length of the recording period can be edited using the on-screen numeric keyboard after tapping the "Length:..." button. Periods of 1 ... 7 days can be configured.

A day is not a calendar day but a 24 hour period. Example: if the recording begins on Tuesday at 9:00, the first day of the recording will end on Wednesday at 8:59. The start time of the recording thus specifies the start of a day, i.e. of a 24 hour period.

Before starting recording, ensure that the time and weekday on the panel is set correctly!

- i** During the recording phase, changes to the time (externally by the master object or direct adjustment on the panel) should be avoided, to avoid affecting the end of the specified recording period during an automatic recording. For this reason, a simulation recording should not take place during a change from summer to winter time.
Example: the recording period is specified as 1 day (24 hours). The recording is started at 8:00 on the first day. If the time were to continue normally, it would be stopped automatically at 7:59 on the next day. If, during the recording phase, the time is put back by 1 hour, then the recording would run for 24 hours but, on account of the new time, would end at 6:59 on the second day. Thus it may occur that telegrams between 7:00 and 7:59 are not recorded or there are time overlaps in the recorded telegram sequence.

The recording can be started by tapping the "Start" button in the "Recording" display group (figure 33). The recording takes all the incoming telegrams of all the selected functions (recording objects) into account and saves them temporarily to the RAM of the panel. During the recording, the number of incoming telegrams is displayed in the first line of the system page of the presence simulation. A maximum of 2,100 telegrams can be recorded. Should a larger amount of telegrams have been reached before the set recording time has elapsed, then the recording will stop. The telegrams received before this time can be saved and then played back later.

- i** Due to the temporary saving of the telegram sequence, the saved data will be lost if the power supply fails or a programming operation is carried out. In this case, a new recording must be started after the device reset.

Each recorded telegram is issued with a time stamp, accurate to the second. The time stamp takes the current time and weekday into account when the telegram arrives. This information is obtained from the internal real time clock of the panel. Marking with a time stamp is important on playing back (see chapter 4.2.4.11.2. Playing a telegram sequence back). The user can also stop a recording before the set recording period has elapsed. To do this, tap the "Stop" button in the "Recording" display group. At the end of the recording, the number of telegrams received and saved is displayed in the status line of the presence simulation (first line on the screen).

- i** Each time a recording is started, the previous recording is deleted.
- i** An active recording can be signalled to the bus using the 1 bit communication object "Recording active", which can be planned in the presence simulation parameter node in the ETS plug-in.
- i** During an active recording, it is not necessary to keep the system page of the presence simulation visible. During this time, the panel can be operated normally.

4.2.4.11.2 Playing a telegram sequence back

After a simulation has been recorded, the saved telegram sequence can be played back. Each telegram was issued with a time stamp on recording. The playback of the saved telegram sequence takes place accurate to the second.

Before the user starts playback, the type of playback must be specified. The type of playback is configured by tapping the "Type: ..." button on the system page of the presence simulation. The display group "Playback" is only visible on the screen when a telegram sequence has been recorded successfully (see chapter 4.2.4.11.1. Recording a telegram sequence).

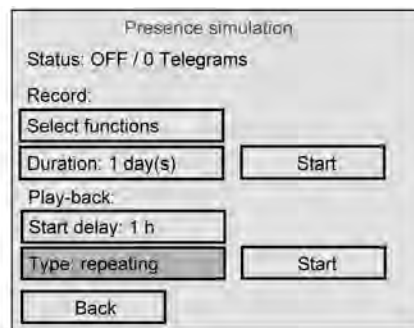

Figure 35: System page of the presence simulation with recorded simulation

A distinction must be made between two different cases when setting the type of playback:

- Playback type "Repeating":
When the telegram sequence is played back, only the time of the individual telegrams is taken into account. The weekday is ignored.
The previously recorded telegram sequence is repeated cyclically until the playback is stopped.
- Playback type "Weekday":
When the telegram sequence is played back, in addition to the time, the weekday upon which the individual telegrams were recorded, is taken into account.
In this case, the telegrams are played back by weekday. No telegram is played back on days why no telegram was recorded.
Example 1: recording only took place on a Tuesday and was active for considerably less than 24 hours. On playing back, the simulation is only executed at the recorded times and only on a Tuesday. The simulation has no effect on other days.
Example 2: recording was limited to 5 days and was started on a Wednesday. Telegrams were recorded on the Wednesday, not on Thursday and Friday (no telegram activity), and telegrams were received again during Saturday and Sunday. On playing back, the simulation is executed on the Wednesday, not on the Thursday and Friday, and then continues on the Saturday and Sunday.
In every case, the recorded telegram sequence is repeated cyclically according to the weekdays until the playback is stopped.

Playback of the presence simulation can be started by tapping the "Start" button in the "Playback" display group (figure 35). The panel then immediately begins to play the telegram sequence back according to the saved time stamp and the configured playback type. Playback can be cancelled at any time by tapping the "Stop" button. In addition, playback of the presence simulation can be started and stopped using the "Start/stop playback" 1 bit communication object.

Optionally, a start delay can be configured for playback. The start delay time can be set by tapping the button of the same name using the on-screen numeric keypad. If a start delay of more than 0 hours has been configured, then tapping the "Start" button means that playback will not start immediately. It is only started automatically when the start delay has elapsed. The delay time thus only has an effect on the start time of the simulation (like delayed tapping of the "Start" button) but not on the saved time stamps of the telegrams. The start delay and the playback operation can be cancelled at any time by pressing the "Stop" button. The progress of

the start delay is displayed in the status line (first line on the "Presence simulation" screen page).

- i** The current weekday is set either directly on the panel or by time telegram (DPT 10,001 3 bytes) via the bus.
- i** The previously recorded telegrams of the simulation are worked through chronologically. The time of processing depends on the starting time of the simulation. If, for example, the recording period began at 8:00 but playback is not started until 9:00, then only those telegrams will be transmitted which were recorded at or after 9:00. Telegrams before this time are only taken into account in the next cycle (only time or time/weekday-dependent). On playing a recording period back, the telegrams are only transmitted once within a cycle. If, during playback, the time of the panel is put back, then the panel will not transmit previously transmitted telegrams of a cycle. If the time is put forward, then the panel detects which telegrams are to be jumped over, and then transmits the telegrams in one go, thus matching the telegram sequence with the current time. The same thing happens if, during the recording phase, the time was put back, for example on changing from summer to winter time. In this case, the panel checks during playback to see if the telegram following the current one is more recent in the recording. If this is not the case, due to the change in time in the recording, then the older telegrams are transmitted immediately until the time stamp matches again.
- i** Active playback can be signalled to the bus using the 1 bit communication object "Playback active", which can be planned in the presence simulation parameter node in the ETS plug-in.
- i** Simulation playback only ever takes place using the group addresses of the recording objects to be sent.
- i** During active playback, it is not necessary to keep the system page of the presence simulation visible. During this time, the panel can be operated normally.

4.2.4.12 Signalling system

4.2.4.12.1 Introduction and basic principles

Introduction

The signalling system allows the inclusion of existing sensors of a KNX/EIB installation in the project planning of the panel to monitor a building or part of a building. The signalling system can display the status of window contacts, motion detectors or glass break sensors and monitors changes in the statuses of these detectors.

The detectors integrated in the signalling system can be combined into up to two security areas. Arming these areas allows monitoring of the secured area for break-ins when people are present in or absent from the building. In addition, sections of the area can be monitored for sabotage. If there is a break-in alarm, visual and acoustic alarms can be activated.

The signalling system can be checked directly on the panel using a separate system page (figure 36). The system status (active detectors, events) and operation (arming/unarming, acknowledgement) is made simple and clear by predefined screen icons and pages. In addition, arming or unarming is possible using other bus subscribers - for example touch sensors or button interfaces and binary inputs with connected operating units. In addition, in the case of an alarm or fault, it is also possible to display system statuses or detector texts on other KNX/EIB display units - e.g. info displays or simple LED displays. The signalling system makes separate communication objects available for this.

It should be noted that a reset to readiness after an alarm or a fault, or the viewing of the event memory is only possible on the panel as a central component.

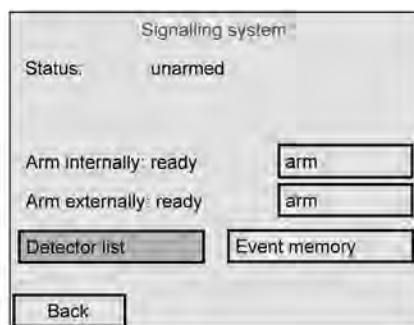

Figure 36: System page of the signalling system

- i** As a function component of the panel, the signalling system is not a complete alarm system. For example, if the main or bus power supply fails, uninterrupted operation is not guaranteed. In addition, no signal encoders or transmission devices can be directly connected to the system, meaning that there is no opportunity to monitor these elements. The panel's signalling system is also not VDS-certified. If such functions or characteristics are required, the a suitable KNX/EIB alarm centre must serve as a replacement.

Security areas and configuration

A security area is an area of the signalling system, which secure specific parts of a building such as individual rooms, building wings or facade areas and monitors them for break-ins. In the security areas, detectors are those components which allow such monitoring. These detectors could be magnetic contacts on windows or doors, motion detectors on walls or ceilings in interiors as well as glass break sensors. Detectors can be connected to the KNX/EIB via suitable components (button interfaces, binary inputs, etc.) or, depending on the device version, be connected to the KNX/EIB directly.

Security areas can be activated and deactivated, i.e. armed and unarmed. Arming and unarming takes places either directly on the panel or using the external KNX/EIB switching

units.

- i** External switching units are components such as keyswitches, transponder units, code keypads or block locks. In many cases, such units are intended for use in alarm or signalling systems and, for this reason, can monitor for sabotage. Simple installation buttons or KNX/EIB button sensors can easily be used as switching units. However, these do not provide any protection against unauthorised sabotage access. For this reason, button sensors are often attached within a building to be protected, for example to activate the external skin monitoring ("internal arming").
External switching units can be coupled to the panel's signalling system using separate 1 bit objects. The sabotage contacts of the switching unit can be included using the "Sabotage" detector input (see chapter 4.2.4.12.2. Detector).

The signalling system makes a distinction between security areas, the interior and the external skin. This distinction allows separate monitoring and arming of different building sections depending on whether authorised people are in them or not. During the project planning of the signalling system in the ETS plug-in, created detectors are assigned to the security areas.

"External skin" security area:

The external skin separates the interior area of a object to be secured, from the external area. Detectors integrated in the external skin can, for example, detect unauthorised access or sabotage to the house or garden door, to the building windows and to the garage door. In these cases, suitable detectors are often magnetic contacts or glass break sensors.

The external skin can be armed separately. Arming usually take place using a switching unit, located within the building (e.g. button on the panel, button sensor). In this case, there are authorised people in the building. Only monitoring of the external skin takes place. Only the internal siren is activated when there is an alarm. This status is called "internally armed".



Figure 37: External skin as signalling area - "internally armed"

"Interior" security area:

Detectors are assigned to the interior of a building to be secured which can protect the interior area, i.e. the lived in spacers of a building, against break-ins and sabotage. Suitable detectors would be magnetic contacts on internal doors or motion detectors on walls or ceilings.

The interior is always armed and monitored together with the external skin. Arming often take place using a switching unit, for example located on the outside, next to the entrance door. However, this switching unit can be located within a building (e.g. button on the panel, button sensor) and can arm the security areas in conjunction with an arming delay (see chapter 4.2.4.12.3. Arming). When armed, no authorised people are in the building. There is then external skin and interior monitoring. The internal siren and the visual alarm are activated when there is an alarm. This status is called "externally armed".



Figure 38: Interior with external skin as signalling area - "externally armed"

System statuses

The signalling system reacts differently to incoming signals or commands, depending on the whether the security areas are armed or unarmed. The signalling system distinguishes between up to five statuses (figure 39).

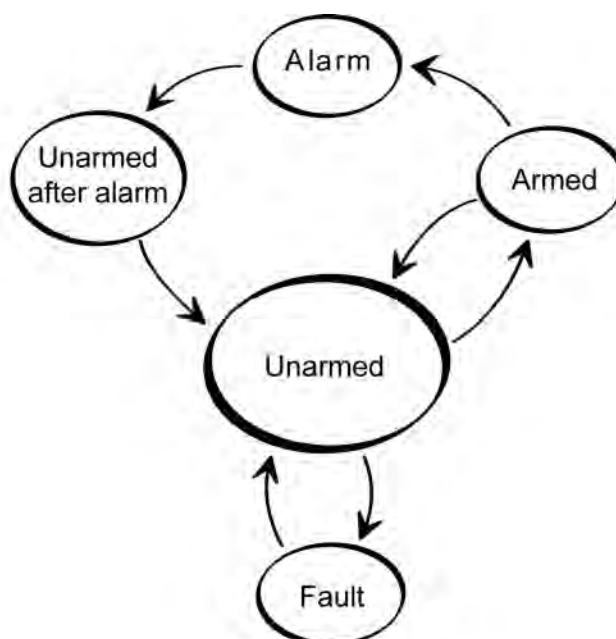

Figure 39: System statuses of the signalling system

A distinction is made between the following system statuses...

- "Unarmed" status:
If both security areas are unarmed, break-in messages in these areas (e.g. a window is opened), or a sabotage messages do not lead to an alarm. Active detectors are then only displayed in the detector list. The system can only be armed from the "Unarmed" status, when the appropriate security areas are ready for arming. The status display of a security area on the panel system page of the signalling system displayed "ready" when detectors in the appropriate area are inactive. If detectors are active, then the status displays "not ready".
In the "Unarmed" status, sabotage signals (active sabotage input) will lead to a fault, which is signalled via the appropriate communication object or directly on the panel on the system page of the signalling system (cf. "Fault" status). The "Unarmed" status can be signalled using the "Arming message, internal" or "Arming message, external" and "Unarming acknowledgement" objects on the bus.

- "Armed" status:
A security area can only be armed when all the detectors assigned to this area are inactive and there is no fault. In this case, the status "Ready" is displayed on the system page of the signalling system.
In addition, this status can be signalled on the bus for each security area using the "Ready to arm ..." status ("0" = Not ready to arm / "1" = Ready to arm).
If security areas are armed, break-in messages in these areas will trigger an alarm. A distinction is made between...

"Internally armed": only the external skin of a building is monitored. Authorised people are located in the interior of the building. No alarm is triggered for as long as the external skin is 'infringed'. Motion detectors installed in the interior detect movements but no alarm is triggered. A sabotage signal will immediately trigger alarm in the "internally armed" status.

"Externally armed": all the internal and external detectors, i.e. both security areas, are monitored. An alarm is triggered when any detector responds (also the sabotage detector).

Should an area not be ready for arming, the panel displays "Not ready" on the signalling system page and the value of the "Ready to arm" object is "0". Before arming in this case, the cause (e.g. an open window) must be detected and eliminated. The detector list can help here, as it displays all the active detectors.

It is possible to configure an arming delay time in the ETS plug-in for both internal and external arming. For example, the delay time is necessary when a switching unit (e.g. keyswitch) is located within an area to be monitored and the area is evacuated before arming. The same applies when the system is armed externally from the panel. The delay time specifies after what time after an arming command (turning of the keyswitch or pressing of the "Arm" button on the panel) the system is actually armed. On setting the time, some extra time should be planned for, in order to allow the system operator to leave the building to be armed correctly, before actual arming. Only when the delay time has elapsed should there be no detectors active, as otherwise arming will not take place.

- "Alarm" status:

If a detector within an armed area responds, the signalling system switches to the "Alarm" status and activates the internal siren and, with additional external arming, also the visual alarm.

If an additional detector triggers after a prior alarm, then a subsequent alarm is activated. In so doing, the internal configured siren is again triggered and, if necessary, switched on again.

An alarm can only be deactivated by unarming using the switching devices or deactivated directly on the panel using the appropriate button.

If an alarm delay time was configured in the ETS plug-in, a "Prealarm" can be activated first. A prealarm can be signalled by the piezo buzzer of the panel and/or by a separate communication object. The system can be unarmed during a prealarm, without triggering an alarm. The transition to "Alarm" status then takes place without unarming only when the appropriate alarm delay time has elapsed, which can be configured separately for internal and external arming. A subsequent alarm is always activated without delay.

- Status "Unarmed after alarm"

After an alarm was reset through unarming (internal siren deactivated, visual alarm still activated), the system switches to the status "Unarmed after alarm". After an alarm, the cause of the alarm must always be determined. In this status, the triggered detectors of the security area affected by the alarm are displayed in the event memory of the panel (see chapter 4.2.4.12.6. Event memory). In so doing, all the events are logged between system arming and unarming. In the "Unarmed after alarm" status, there must first be an acknowledgement using the button of the same name on the panel in order to return to the "Unarmed" status. The system can only be rearmed when all the previously tripped detectors of the affected security areas were reset.

- "Fault" status:

The system switches to the "Fault" status when the sabotage detector has tripped or if, during detector monitoring, at least one missing detector was detected. A fault restricts the function of the signalling system to such an extent that proper operation can no longer be guaranteed.

If a fault results from the "Unarmed" status, then the system cannot be rearmed (status display on the panel "Not ready"). In this case, the fault must be detected using the detector list and eliminated through acknowledgement (see chapter 4.2.4.12.5. Fault). In the armed status, sabotage or a missing detector will immediately trigger an alarm. In this case, the system will only switch to the "Fault" status, after the alarm was acknowledged.

A fault message can be signalled to the bus using the "Fault" object.

4.2.4.12.2 Detector

Detector types

The detectors of the signalling system are components which communicate via the KNX/EIB, which monitor a part of a building and signal a break-in or attempted break-in on the panel. Commonly used detector types supported by the panel include magnetic contacts, glass break detectors and motion detectors. Special detectors can also be sabotage detectors, allowing sabotage or fault contacts of alarm encoders or switching devices (e.g. keyswitches) to be integrated in the signalling system. Also, lock monitors, such as bolt switch contacts, are detectors permitting a positive drive. This means that, for example, an area can only be armed when the front door is closed, i.e. the bolt switch contact is not active.

A triggered detector allocated to a security area is immediately evaluated in the signalling system and, when armed, immediately leads to an alarm. When armed, all the detectors of a security area are evaluated after a delay after triggering, if an alarm delay time was configured (see chapter 4.2.4.12.4. Alarms). When the system is unarmed, triggered detectors - such as an open window - prevent active arming of the affected detector areas. When the system is unarmed, a triggered sabotage detector causes a fault display and thus prevent arming of the system. When armed, an active sabotage detector immediately triggers a sabotage alarm.

The detector type (contact, movement, glass break) is defined for detectors of a security area and configured separately in the ETS plug-in for each detector (see next section). The type "sabotage detector" is specified automatically by the use of a separate communication object, independently of the security areas.

Creating detectors and detector communication

During project planning of the signalling system, detectors are added in the form of detector inputs in the ETS plug-in by clicking the right mousebutton on the parameter node "Interior security area" or "External skin security area". A total of 40 detectors can be allocated to each of the two security areas in this way.

Each newly created detector can be assigned a detector text in the corresponding parameter node, which then clearly identifies the detector. This text may be a maximum of 14 characters long (e.g. "Kitchen window", "Garage door") and later, during system operation, if there is activity on the part of the detector, an alarm or a fault, is either displayed in the detector list on the panel screen or in the event memory. Optionally, if there is an alarm, the detector text can be transmitted to the bus using separate 14 byte communication objects.

The detector type of a detector (contact, movement, glass break) is specified by the parameter of the same name in the parameter node of the detector input. The configured type only specifies the text display in the detector list (see next section) and has no further effect on the behaviour of a detector.

Each detector input has its own 1 bit communication object. Usually, the detectors are connected to the bus using suitable KNX/EIB components (such as binary inputs, button interfaces, etc.) and are thus connected to the detector system. The connection is made between the detector object of the panel and the object of the bus device to which the detector is connected with one group address each. For reasons of clarity and detector monitoring, only one single detector may be connected to each detector object of the panel (Detector -> Detector text -> Security area).

In the ETS plug-in, each detector input can be configured to different telegram polarities, i.e. individual detectors can be active with a "1" telegram or a "0" telegram. The polarities configured in the signalling system must agree the flank parameters of the other bus subscribers. The following table clarifies the relationship between telegram polarity and flank evaluation in the bus device of the detector.

Detector contact type / Status	Flank reaction in the detector bus device	Telegram value	Parameter in the signalling system	Detector triggers
NO contact / not actuated	Rising = ON	1	Active on 0	No
NC contact / Actuated	Falling = OFF	0	Active on 0	Yes
NO contact / not actuated	Rising = OFF	0	Active on 1	No
NC contact / Actuated	Falling = ON	1	Active on 1	Yes
NO contact / Not actuated	Falling = OFF	0	Active on 1	No
NO contact / Actuated	Rising = ON	1	Active on 1	Yes
NO contact / Not actuated	Falling = ON	1	Active on 0	No
NO contact / Actuated	Rising = OFF	0	Active on 0	Yes

Table 11: flank evaluation and telegram polarity of a detector telegram

Example: with the setting "Input active on 1" in the detector system, a glass break sensor may only trigger when there is a glass break and, in this case, the binary input, to which the glass break sensor is connected, transmits a "1" telegram to the bus.

The sabotage detector must not be created specially. The sabotage input is created independently of the security areas in the "Signalling system" parameter node as standard and can be connected to a group address. A fault triggered by a sabotage input has a global effect on all the areas of the signalling system and requires special acknowledgement (see chapter 4.2.4.12.5. Fault). In addition, the telegram polarity of the sabotage detector input is permanently predefined and cannot be set. The sabotage input of the signalling system triggers when a "1" telegram is received via the "Sabotage" object.

- i** If a detector input has been created in a security area in the ETS plug-in, but has not been linked to a group address, the plug-in will generate an information message before the panel is programmed ("Download" command). After the panel is commissioned, detector inputs without linked group addresses or without a communication partner would cause a fault in the signalling system, as the detector monitoring would detect a faulty detector input (see "Detector monitoring" section below).
To prevent function faults in system operation, all the detector inputs created in the plug-in should also be linked with group addresses and possess a communication partner in the bus.

Detector list

All the active detectors are displayed in the detector list. The display is opened by pressing the "Detector list" button on the system page of the signalling system (figure 36). This allows easy detection of which detectors are preventing system arming, for example. In addition, it is easy to see at any time which windows and doors are open in the building. In addition, missing detectors and a triggered sabotage detector are entered in the detector list, allowing identification of the cause of a fault.

The following events are shown summarised in the detector list...

- All the active detectors of the two security areas
(Entry "<Detector name> + <Identification of the detector type>"
Example: "Front door opened", "Glass break, kitchen window", "Movement in corridor"),
- An active sabotage detector ("Sabotage" entry),
- All the missing detectors (Entry "<Detector name> + <Text, detector missing>"
Example: "front door detector missing").

An entry only remains visible in the detector list until the appropriate detector is inactive again or has been detected as present.

If there are a number of active or missing detectors, the detector list may consist of several screen pages. It is possible to navigate between the pages using the function buttons shown at the edge of the screen.

Detector monitoring

Within a configurable monitoring period, the signalling system checks that the detectors created in the security areas exist, i.e. that they are still connected to the KNX/EIB and are functioning. For this, the panel cyclically sends a read telegram, via the group address connected to the detector input, to the bus subscriber to be tested, e.g. to the transmitting object of the binary input. This bus subscriber must then immediately send a response telegram back to the panel. This response must have reached the panel within a timeframe of 2 seconds.

Should a contacted detector not respond or respond after a delay, then the signalling system will check the appropriate detector a second and - if again no response is received - a third time within a short period. If, after the third query, the detector has still not responded, a fault (in the "Unarmed" status) or in alarm (in the "Armed" status) is triggered without further delay, depending on the system status.

If a missing detector causes an alarm, additional missing detectors can trigger subsequent alarms.

Each detector of a security area created in the ETS plug-in is monitored in the manner described. The "Detector poll interval", which can be set in the parameter node of the signalling system, defines the time between two read telegrams, i.e. the time between two detector tests. The signalling system polls all the created detector inputs in turn in this way.

Example: poll interval: 10 s, 40 detectors have been created. -> A detector is polled every 10 s. After approx. 400 s, all the detectors have been tested. After this, the cycle test is continued again with the first detector.

The signalling system tests detectors considered missing cyclically at brief intervals, in order to be able to detect quickly whether or not the detector has reconnected. This is important for resetting a fault.

- i** Detector monitoring does not take the sabotage input into account or the inputs for arming/unarming the security areas.
- i** After switching on the power supply of the panel, or after a programming operation, the signalling system quickly tests all the created detectors during device initialisation for their existence and, during the responses, evaluates the transmitted detector statuses (active / inactive). To avoid faults in the signalling system, during panel commissioning all the detectors should have been commissioned properly and function.
In addition, the detector poll may cause a delay of maximum 40 s before the signalling system is ready for arming after a device reset (precondition: all the detectors are inactive).

- i** It should always be ensured that each detector input created in the ETS plug-in is also linked to a group address and that there is a communication partner in the bus. For detector monitoring to function, the "Read" flags must be set on the objects to be transmitted by the bus devices of the detectors.
- For each detector to be monitored, it is also important that the group addresses of the detectors to be transmitted are clear, i.e. are not connected to any other transmitting bus subscriber. Each messages must have an independent connection to its own detector input on the signalling system. Only then can it be ensured that only the contacted detector responds and that detector monitoring is clear.

4.2.4.12.3 Arming

Arming/unarming the security areas

The signalling system makes a distinction between security areas, the interior and the external skin. This distinction allows separate monitoring and arming of different building sections depending on whether authorised people are in them or not. For this reason, the panel allows internal and external arming (see chapter 4.2.4.12.1. Introduction and basic principles). A security area can only be armed when all the detectors assigned to this area are inactive and there is no fault in the system. The status of the signalling system and the individual security areas is always displayed on the system page of the signalling system (figure 36).

Arming and unarming takes place either directly on the panel or using KNX/EIB switching units, such as button sensors or button interfaces or keyswitches connected to binary inputs. There are also two separate 1 bit communication objects available for arming the bus, one for internal arming and one for external arming. The telegram polarity of these objects is fixed: "1" = Arm / "0" = Unarm.

Arming can take place on the panel using the "Arm" and "Unarm" buttons on the system page of the signalling system. The panel automatically switches the function (Arm / Unarm) according to the current system status. Local arming using the buttons can be prevented in the parameter configuration of the ETS plug-in by hiding the buttons.

Arming without arming delay:

The area to be armed must be ready for arming. On internal arming, the signalling system only tests the external skin whilst on external arming, both the internal skin and the interior are tested for arming readiness. The detector list helps the system operator to detect active detectors which prevent arming readiness.

Pressing the "Arm" button on the panel" or a "1" telegram to the "Internally armed" or "Externally armed" object causes the system to switch to the "Armed" status immediately.

Arming with an arming delay:

Arming with an arming delay is often used when the switching device (e.g. the panel or a button sensor) is installed in the secure area of the building. In this case, the system operator must be able to arm the system and still be able to leave the building in time. The arming delay can be configured separately, using the parameter of the same name in the ETS plug-in, for internal and external arming. Delay times of 0 s to 255 s can be configured. The setting "0 s" (presetting) deactivates the arming delay for the appropriate arming operation. When setting the time, a time reserve should be planned, so that the user is still able to leave the building to be secured correctly before actual arming.

The delay time specifies after what time after a arming command (turning of the keyswitch or pressing of the "Arm" button on the panel) the system is actually armed. In so doing the signalling system only checks the arming readiness of the security areas after the delay time has elapsed.

Example: the system is to be armed externally on the panel. For external arming, the system operator must leave the building. The front door is still open. Therefore, the panel displays "not ready". However, the operator can still carry out the arming command on the panel. The panel starts the arming delay. Within this time, the owner leaves the building and locks the front door. This makes the system ready for arming (no more detectors are active). When the delay time has elapsed, the signalling system checks for the arming readiness system status. If it is ready, the system arms immediately.

Should, however, a detector still be active at the end of the arming delay, (e.g. front door not closed or window opened), then arming does not take place. Here too, the detector list helps the system operator to detect active detectors which prevent arming readiness before setting the arming command. If the system does not arm after the delay time has elapsed, then no acknowledgement will take place either (see next section).

i An elapsing arming delay can be cancelled at any time by unarming.

- i** To be able to place an arm command in areas for which an arming delay has been configured, even in the "Not ready" status, the "Arm" button of the appropriate arming circuit remains visible on the system page of the signalling system even in the "Not ready" status.

Unarming:

In the "Armed" status, the system can be unarmed at any time. To do this, either the "Unarm" button must be pressed on the panel or a switching device must be set to "Unarmed". The system then switches to the "Unarmed" status immediately.

If an alarm has occurred, then an Unarm command will reset the alarm (deactivation of the internal siren) and switch to the "Unarmed after alarm" status. If there is an alarm delay, then unarming within the elapsing delay time (prealarm) will prevent a alarm from being triggered (see chapter 4.2.4.12.4. Alarms).

- i** The following always applies: if there is internal arming or an internal arming delay is elapsing, then external arming is not possible. Internal unarming must take place and then, if the system is ready to arm, external arming is possible. The reverse is true in like manner.
- i** The signalling system only reacts to an arming or unarming command, when a system status change is possible (Unarmed -> Armed / Armed -> Unarmed / Alarm -> Unarmed after alarm). Repeating telegrams (Armed -> Armed / Unarmed -> Unarmed - e.g. for KNX/EIB switching units with cyclic transmission) are ignored by the signalling system.
- i** Arming or unarming is saved in the event memory along with the date and time (if necessary, only after the arming delay has elapsed) (see chapter 4.2.4.12.6. Event memory).

Signalling during arming/unarming

In the case of external arming, the signalling system can confirm its status change "Unarmed" to "Armed" via the visual signal encoder output ("acknowledge"). This means that it is possible to detect clearly whether the system has responded to an arm command as required or not. This is primarily important when the system is operated remotely (without being to see the panel) or in the case of an arming delay. The visual signal encoder will not give a special acknowledgement on unarming. The signal encoder is also not controlled for internal arming.

Whether the visual signal encoder is controlled in the case of external arming can be configured in the ETS plug-in using the parameter "Visual acknowledgement on external arming" in the parameter node of the signalling system. This means that it is possible to switch visual feedback off.

In addition, various signals are available to signal the status of the signalling system. These signals are 'run out' using separate KNX/EIB 1 bit objects and can be tapped.

The following objects can be planned in the signalling system node in the ETS plug-in...

- "Ready to arm, internal" and "Ready to arm, external":
These objects signal the readiness of the assigned security areas separately for internal or external arming. If the areas are ready for arming, the object value is "1". If they are not ready, the object value is "0".
When the system is armed (no matter whether internally or externally), **both** objects switch back to "0", irrespective of which status is displayed on the signalling system page on the panel.

- "Arming message, internal" and "Arming message, external":
These objects signal whether the appropriate security areas are armed or unarmed separately for internal or external arming. Signalling is static for the length of the status. An object value "1" means "Area(s) armed", whilst an object value "0" means "Area(s) unarmed". "Unarmed" is signalled in the system status "Unarmed after alarm".

 - "Arming acknowledgement":
This object dynamically signals successful internal or external arming for the length of the "Arming acknowledgement time" set in the ETS plug-in. No distinction is made between the security areas. The object value switches to "1" as soon as the system has armed. The object value returns to "0" automatically when the arming acknowledgement has elapsed. It is possible to cancel arming acknowledgement by unarming before the arming acknowledgement time has elapsed.

 - "Unarming acknowledgement":
This object dynamically signals successful internal or external unarming for the length of the "Unarming acknowledgement time" set in the ETS plug-in. No distinction is made between the security areas. The object value becomes "1" as soon as the system has unarmed (status change "Armed -> Unarmed" or "Alarm -> Unarmed after alarm"). When the status changes from "Unarmed after alarm -> Unarmed", there is no unarming acknowledgement. The object value returns to "0" automatically when the unarming acknowledgement has elapsed. It is possible to cancel unarming acknowledgement by arming before the unarming acknowledgement time has elapsed.
- i** If, after an arming command (or after an arming delay has elapsed), the signalling system does not arm, because the affected security areas are not ready to arm, there will be no acknowledgement. In this case, the dynamic object "Arming acknowledgement" and, in the case of external arming, the visual signal encoder are not controlled (no negative acknowledgement).
- i** To be able to distinguish between dynamic objects for arming and unarming, the acknowledgement times for "Arming" and "Unarming" should be of different lengths. When arming or unarming is repeated ("Armed" -> "Armed", "Unarmed" -> "Unarmed"), there is no retriggering of the dynamic signalling. This is only transmitted once on changing status.

4.2.4.12.4 Alarms

Activating and deactivating an alarm

If a detector within an armed area responds, or a sabotage detector triggers when armed or any detector is found to be missing, the signalling system switches to the "Alarm" status and activates the internal siren and, with additional external arming, also the visual alarm. For this, "1" telegrams are transmitted to the bus using the corresponding 1 bit communication objects. In addition, the panel transmits a "1" telegram via the "Alarm" object. This allows any switching function to be executed in the bus. In addition, the signalling system uses the 14 byte object "Alarm detector text" to display the detector text of the detector which triggered the alarm.

The internal siren is an alarm encoder activated for a set period of time. The system project planner must set the switching length of the internal siren in the ETS plug-in. Switching times of 2 s to 255 s are possible. The signalling system automatically deactivates the internal siren when the switching time after the alarm is triggered has elapsed. The visual alarm (e.g. a flashing light on the exterior of the building) remains activated for the entire length of the alarm status (see "Alarm acknowledgement" section below).

An alarm and the detector causing it are logged in the event memory of the panel (see chapter 4.2.4.12.6. Event memory).

An active alarm can be switched off by unarming on the panel or using a KNX/EIB switching unit. In this case, the panel switches the internal siren off if it has not already been switched off automatically after a period of time has elapsed, transmits a "0" telegram to the bus via the "Alarm" object and switches to the status "Unarmed after alarm". The visual alarm (for external alarming) remains switched on.

- i** In the case of an alarm, the panel can also send an e-mail with a predefined text, providing that the Ethernet functionality of the panel is used and an e-mail mailbox was configured. For this, the "Alarm" object of the signalling system can be linked to the "Send e-mail" object of an event e-mail of the panel using an internal or external group address (see chapter 4.2.4.13.1. Introduction).

Alarm delay / Prealarm

An alarm delay can optionally be configured for internal and external alarm. An alarm delay is often used when the switching device (e.g. the panel or a button sensor) is installed in the secure area of the building. In such cases, authorised people must be able to enter the secured building area, meaning the status the switching device for unarming can only be reached after a delay.

The alarm delay can be configured separately, using the parameter of the same name in the ETS plug-in, for internal and external arming. Delay times of 0 s to 255 s can be configured. The setting "0 s" (presetting) deactivates the alarm delay for the appropriate arming operation.

If an alarm delay time is running during system operation, a "Prealarm" can be activated first. Depending on the parameter configuration, a prealarm is signalled by the piezo buzzer of the panel and/or separate 1 bit communication objects. During a prealarm, an authorised person can unarm the system without triggering a 'real' alarm. The transition to the "Alarm" status only takes place if the system is not unarmed during the prealarm.

- i** A prealarm configured in the ETS plug-in only functions if an alarm delay time of more than 0 s has been configured. Otherwise the prealarm will not be executed during system operation.
- i** An alarm due to a triggered sabotage detector or a missing detector is always executed without delay.

Subsequent alarm

If an additional detector of an armed security area triggers after a prior alarm, then a subsequent alarm is activated. In so doing, the internal configured siren is again triggered and, if necessary, switched on again. A detector which previously triggered an alarm cannot trigger a second subsequent alarm.

A subsequent alarm is always activated without delay, even with a planned alarm delay.

An subsequent alarm and the detector causing it are logged in the event memory of the panel (see chapter 4.2.4.12.6. Event memory). In addition, the signalling system uses the 14 byte object "Alarm detector text" to display the detector text configured in the ETS plug-in of the detector which triggered the alarm.

Alarm acknowledgement / "Unarmed after alarm"

Each alarm must be acknowledged directly on the panel. Without alarm acknowledgement, it is not possible to switch to "Unarmed" status and thus additional arming. The system operator can acknowledge an alarm in the status "Unarmed after alarm".

Primarily, there are two methods of acknowledging an alarm...

- Separate unarming + acknowledgement:

An active alarm (internal siren + "Alarm" object switched on) can - as described above - be deactivated by unarming. The system switches the internal siren off if it has not already been switched off automatically, transmits a "0" telegram to the bus via the "Alarm" object and an unarmed acknowledgement to the bus and switches to the status "Unarmed after alarm". The visual alarm (for external alarming) remains switched on.

In the "Unarmed after alarm" status, the operator can inspect the event memory directly on the panel to see which detector triggered the alarm at which time. Usually, the alarm can then be confirmed by pressing the "Acknowledge" button on the panel and then reset completely. The system then switches the visual signal off (for external alarms) and then switches to the "Unarmed" status. In this case, there is no additional unarming acknowledgement. The panel transmits the text "No alarm" to the bus via the 14 byte object "Alarm detector text".

In the "Unarmed after alarm" status, the piezo buzzer of the panel is controlled in order to alert the user to go to the panel and acknowledge the alarm.

- Unarming by acknowledgement:

An alarm can also be acknowledged directly without separate unarming and thus reset. For example, such behaviour is wise when the internal siren set for a specific time after an alarm has already turned quiet, i.e. need not be turned off, or the system is operated directly on the panel. For this, the "Acknowledge" button can be pressed on the signalling side of the panel in the "Alarm" status.

With such operation, the signalling system completely deactivates the alarm and acknowledges it at the same time. Deactivating the alarm switches off the visual alarm (for external alarms) and the internal siren, if this has not already been switched off automatically. In addition, the system transmits a "0" telegram via the "Alarm" object and the text "No alarm" to the bus via the 14 byte object "Alarm detector text". The system then immediately switches to the status "Unarmed" without any separate unarming acknowledgement. This type of operation does not set the status "Unarmed after alarm". Before or after the "Acknowledge" button is pressed, the system operator can inspect the event memory directly on the panel to see which detector triggered the alarm at which time.

- i** After an alarm has been acknowledged, the system automatically switches to the "Fault" status, if, for example, the sabotage input was the detector triggering the alarm. This subsequent fault must then be acknowledged separately on the panel. The cause of the fault must have been eliminated for a fault message to be acknowledged (see chapter 4.2.4.12.5. Fault).

4.2.4.12.5 Fault

Cause of fault and fault behaviour

The signalling system switches to the "Fault" status when the sabotage detector has tripped in unarmed or if, during detector monitoring while unarmed, at least one missing detector was detected. If the system is armed, then these events will lead to an immediate alarm. In this case, the system will switch to the "Fault" status, when the alarm has been acknowledged. A fault restricts the function of the signalling system to such an extent that proper operation can no longer be guaranteed. A fault causes the system to no longer be armed for as long as the fault has not been eliminated. The detector list and the event memory can be used to detect the cause of the fault and the time the fault was activated.

If there is a system fault, the panel transmits a "1" telegram via the "Fault" object. This allows any switching function to be executed in the bus along with other signalling operations, e.g. using a transmission device. An e-mail, predefined in the panel, can be set by linking this object with an e-mail event (see chapter 4.2.4.13.1. Introduction).

If the fault was triggered by a missing detector, the signalling system uses the 14 byte object "Fault detector text" to display the detector text of the faulty detector. If several detectors are missing, then the detector text of the detector is transmitted which was most recently detected as missing.

If the fault was triggered by the sabotage detector, then the text "Sabotage" is transmitted to the bus via the 14 byte object.

The fault status continues to remain active, even if the cause of the fault has already been eliminated. The status is only reset after the system operator has acknowledged the fault directly on the panel.

Acknowledgement of a fault message

A fault must always be acknowledged directly on the panel. Without a fault acknowledgement, it is not possible to switch back to "Unarmed" status and thus additional arming. The cause of the fault must have been eliminated in order to be able to acknowledge a fault. This means that the sabotage detector may be active before acknowledgement, and all the detectors of the security areas must have been detected as existing. The detector list can be used to detect which detectors may be preventing the acknowledgement of a fault.

After the operator has acknowledged a fault, the panel uses the "Fault" object to transmit a "0" telegram and, via the 14 byte object "Fault detector text", the text "No fault" to the bus. After this, the signalling system is ready for operation again.

- i After an alarm has been acknowledged, the system automatically switches to the "Fault" status, if, for example, the sabotage input was the detector triggering the alarm. This subsequent fault must then be acknowledged separately on the panel in the manner described.

4.2.4.12.6 Event memory

The signalling system has an event memory, which is non-volatile should the mains or bus power supply fail, in which specific fault messages and all the events in armed security areas can be recorded.

The following events and fault messages are given time and date stamps and logged in the event memory...

- "Arming, internal" (internal arming),
- "Arming, external" (external arming),
- "Unarming, internal" (internal unarming),
- "Unarming, external" (external unarming),
- "Alarm" (also subsequent alarms),
- "Detector activated: <Detector text>" (Detector which caused the alarm or subsequent alarm),
- "Alarm reset" (acknowledgement of an alarm),
- "Sabotage" or "Detector missing: <Detector text>" (cause of the fault),
- "Acknowledgement" (fault acknowledgement),
- "HW: Reset" (return of power supply, programming operation).

i Active detectors are not recorded in the event memory in the "Unarmed" status.

The event memory is opened by pressing the button of the same name on the system page of the signalling system. A new system page opens, in which all the events are displayed in chronological order.

The event memory can hold a total of 64 entries (max. 8 display pages of 8 lines). Each event is given a separate entry. The memory is organised as a "ring memory". When the memory limit has been reached (= 64 events), a new event will overwrite the oldest event. The event memory cannot be deleted. The contents are maintained when the main power supply fails or there is a programming operation.

4.2.4.12.7 Behaviour after a device reset

After switching on the mains power supply of the panel or after a programming operation, the signalling system always switches to the "Unarmed" status. Then the signalling system quickly tests all the created detectors of the security areas for their existence and ability to transmit and, during the responses, evaluates the transmitted detector statuses (active / inactive). This checks the security areas for their readiness to arm. During initialisation, the detector poll may cause a delay before the signalling system is ready for arming after a device reset (precondition: all the detectors are inactive). Should an active sabotage detector or a missing detector be detected, then the system switches to the "Fault" status.

Immediately after a reset, the signalling system generates a defined object status by setting all the KNX/EIB communication objects to values, which correspond to the set system status. The system also transmits telegrams.

- i The panel, and thus also the signalling system, switches off when the mains power supply fails. If the mains or bus power supply fails, uninterrupted operation is not guaranteed. Detector status, alarm and fault signals are not saved when the bus or mains power supply fail.

4.2.4.13 e-mail messages

4.2.4.13.1 Introduction

If the panel is connected to a network via the Ethernet interface, the e-mail function can be used. e-mail is a service in computer networks allowing electronic messages to be exchanged between a sender and one or more recipients. Alongside the World Wide Web (www), e-mail is the most currently used service on the Internet.

The panel is also able to receive e-mail messages and display them on the screen and also to send e-mail messages. To use this function, the panel operator must possess a valid e-mail mailbox in a local network or the Internet. Usually, most Internet Service Providers (ISP) offer their customers e-mail mailboxes. The panel allows communication with up to five different e-mail mailboxes.

it is only possible to configure the individual e-mail mailboxes in the PC Client software (see chapter 4.3.1. Introduction, installation and program start). In this way, the panel operator can configure their mailboxes independently of the ETS.

At least one valid e-mail mailbox must be specified in the PC Client software, in order to be able to send or receive messages.

4.2.4.13.2 Displaying e-mail messages

Synchronising mailboxes

The panel allows the evaluation of up to five different e-mail mailboxes. The access data for a mailbox are set using the PC Client software (see chapter 4.3.1. Introduction, installation and program start). The panel supports the synchronisation of mailboxes to mail servers using POP3 (Post Office Protocol of Generation 3) or alternatively via IMAPv4 (Internet Message Access Protocol of Version 4). These protocol variants can be configured independently in the PC Client software for the up to five mailboxes.

The panel cyclically polls all the mailboxes using the set protocol and checks to see if new e-mail have arrived. The poll time (time between the cyclic synchronisation operations) can be configured for each mailbox in the e-mail settings of the PC Client software, allowing demand-orientated updating of the displayed messages on the panel.

In addition 'manual' polling of the mailboxes is possible directly on the panel (see section "Displaying e-mail messages" below).

- i** For the panel to be able to synchronise the mailboxes cyclically without faults, and thus receive e-mail messages, the LAN connection (Ethernet operation) and, if necessary, the WAN connection (Internet) must be available without interruptions. It is generally advisable to have a suitable flatrate connection (e.g. DSL Flat) for synchronisation with Internet mailboxes, in order to keep the telephone and Internet connection costs as low as possible.

The panel offers the option of information other devices, via switching objects, on the KNX/EIB about the arrival of new e-mail messages. In this way, display elements on user pages of the panel can be controlled, which then provide information on the arrival of new e-mail messages. The "e-mail" parameter node of the ETS plug-in contains five 1 bit communication objects; one object per mailbox. As soon as the panel detects at least one new message in a mailbox, it transmits a "1" telegram to the bus via the corresponding object. This operation only ever takes place once for each synchronisation operation. The first time mailboxes are synchronised after a device reset, the panel always signals new e-mails, if there are messages in the mailbox, even if they are older messages.

The panel automatically transmits a "0" telegram about mailbox objects onto the bus, as soon as the panel operator opens a mailbox via the "Mailboxes" system page (figure 40), and thus displays the contents.

In addition to the communication objects, the panel also displays newly-arrived e-mails in a mailbox using a "letter icon" (42) within the mailbox buttons (see next section).

- i** The panel automatically synchronises the mailboxes for the first time 1 minute after a device reset (return of mains power, programming operation). There is no automatic synchronisation before this time has elapsed, meaning that e-mail messages are displayed after a delay after a reset (see next section).

Displaying e-mail messages

The operator of the panel can display the contents of their mailboxes on the device display at any time and thus read the e-mail messages. To do this, they must open the "Mailboxes" system page (figure 40). It is possible to jump to this page by opening the page using a function button.

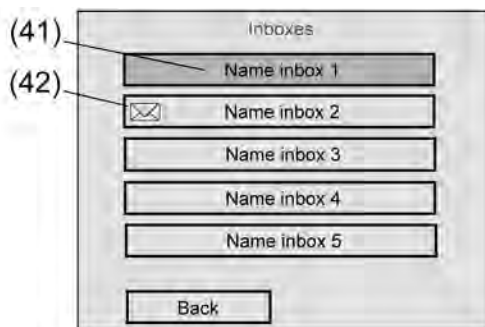

Figure 40: System page for mailboxes

(41) Display name of a mailbox (specified in the PC Client software)

(42) "Letter icon" to signal new e-mails in the mailbox

A button is displayed in the mailbox overview for each active e-mail in the PC Client software (see chapter 4.3.1. Introduction, installation and program start). The display name of each mailbox, as entered in the PC Client software, appears as text in the buttons (41) and thus clearly identifies the mailboxes. Mailboxes with new messages are indicated by a "letter icon" (42).

As soon as the operator taps a mailbox button, the panel switches to the inbox display page of the appropriate mailbox (figure 41).

i Pressing a mailbox button for a long time (> 5 s) synchronises the appropriate mailbox with the mail server. This allows manual synchronisation in addition to the cyclic mailbox polling by the panel.

It should be noted that the synchronisation operation may take several seconds. For this reason, it is necessary to wait after manual synchronisation until the inbox is opened.

i Optionally, each mailbox and the main e-mail page "Mailboxes" can be protected by passwords. Should password protection be required, then the password levels of the panel must be assigned in the "e-mail" parameter node in the ETS plug-in. If a mailbox is protected by a password, then the display page of the inbox (figure 41) is only displayed if the password was input correctly.

The passwords can be set using the "Adjust passwords" system page (Service page -> Area 3 <Administrator> -> Passwords).

i If the panel could not synchronise the mailboxes (e.g. connection fault in the network / there has been no synchronisation on the mail server or after a device reset), then the panel confirm the operation in the negative with an acoustic tone when the mailbox button is tapped. In this case, the panel does not switched to the inbox display page.

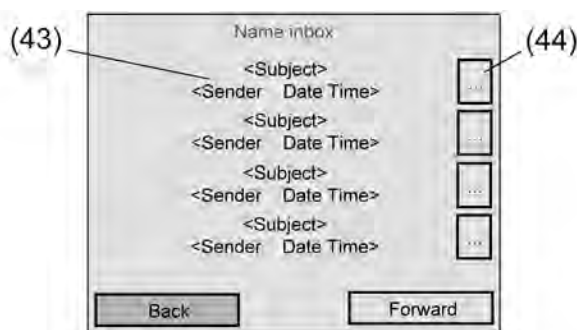

Figure 41: Inbox display page of a mailbox

(43) Message header of the e-mail

(44) "Read" button of an e-mail

An e-mail is primarily divided up into the two areas "Message header" and "Message contents". The inbox display page firstly displays only the message headers to give the user a quick overview and to increase handling speed. The messenger header of an e-mail (43) is displayed in two lines on the display page. The subject of the e-mail is displayed in the first line. The second line contains the sender, the date and the time of the message.

The panel can evaluate and display a maximum of 32 e-mail messages in each mailbox. Up to four message headers can be displayed on each inbox display page. If there are more e-mails in the mailbox, then the additional message headers are displayed on the ext pages, which can be accessed using the "Forward" button. If a mailbox contains more than 32 messages, only the most recent 32 e-mails are displayed.

Pressing the "Back" button leaves the inbox and causes a jump back to the mailbox system page.

The message contents of an e-mail can be displayed by pressing the "Read" button to the right of a message header (44) briefly. Long actuation (> 5 s) of this button causes the panel to delete the appropriate e-mail immediately without displaying the message contents. This allows quick and easy removal of spam mails from the mailbox, for example.

After brief actuation of the "Read" button, the panel polls the complete mail from the mail server. During this operation, which may take some time, depending on the size of the message contents, "Please wait, loading data..." is displayed on the panel screen. An hourglass in the centre of the screen also symbolises the wait operation graphically.

In Read mode, after a successful load operation, the panel displays only the message contents (plain text) of the polled message. No hyperlinks in the text are evaluated. The panel does not display HTML or RTF contents or e-mail attachments. Should an e-mail message contains only the elements just named, and no plain text, then pressing the "Read" button will cause the panel to activate the internal piezo buzzer briefly. The same thing occurs when there are no e-mails in the mailbox.

In Read mode, a maximum of nine lines of text are displayed on the panel screen. If the e-mail message contains more lines of text, then pressing the "Forward" button in the message text switches to the second page. If the text is longer than two pages, then it is cut off. Pressing the "Back" button exits Read mode for e-mail messages. Tapping the "Delete" button causes the panel to delete the e-mail completely on the mail server.

- i** **Caution:** an e-mail deleted on the mail server by the panel cannot be restored.
- i** The following information should be observed with regard to the inbox protocol (IMAPv4 , POP3) configured in the PC Client software:
 - With IMAPv4, only the "Inbox" directory of the mail server is synchronised. The panel does not poll other directories. In addition, the panel cannot modify the directory structure on the IMAP mail server. With IMAP, the e-mails stay on the server. The panel only ever downloads a copy of the message.
 - With POP3 too, only copies of the messages are downloaded. The originals remain on the mail server until 'Delete' is pressed on the panel.
- i** The panel does not support encryption of the communication of the mail server (e.g. SSL).
- i** Newly arrived e-mails are not signalled on the screen for as long as the inbox display page is shown or Read mode is active. New messages are only visible on the screen with the "Letter icon" (figure 40) when the inbox display page is exited. The newly arrived messages can be read the next time the display page is opened.
Irrespective of the signalling of new e-mails on the panel screen, it is possible to display newly arrived messages using the "New message" communication objects at any time.

General information on e-mail text display

The character set of the panel is Windows codepage-orientated. Incoming message texts are usually encoded as ISO codepage or UTF-8. The panel converts the incoming texts, including special characters (e.g. Ää Öö Üü ß) to the system character set selected in the ETS plug-in. When an incoming character is not contained in the system character set, then this character cannot be display and is labelled with "?" in the device. This may occur, for example, when a panel is set to the Western European character set 1252 and e-mails are received from the Eastern European area (e.g. ISO 8859-2). As these two zones are not intercompatible, there may be characters which cannot be displayed.

Conversion of the character sets requires some time, meaning that short waiting times may occur when reading e-mail messages - in particular e-mails contains a large amount of text.

4.2.4.13.3 Sending e-mail messages

Sending e-mail messages

The panel is able to send predefined texts as "event e-mails". The text contents of the event e-mail as well as the recipient address are specified in the ETS plug-in by the project planner before the panel is commissioned. Sending of texts is triggered by switching telegrams, which receive either KNX/EIB group addresses or internal group addresses.

Clicking the right mousebutton in the "e-Mail -> Event e-Mail" parameter node in the ETS plug-in allows the creation of up to 50 event e-mails. A 1 bit communication object "Send e-mail" is shown for each event e-mail.

Within the parameter node of a event e-mail, the project planner specifies the following properties...

- "Designation": identifying text, which is only displayed in the name of the parameter node of the event e-mail in the ETS plug-in.
- "Send e-mail on": definition of the telegram polarity for the "Send e-mail" object of the corresponding event e-mail. The e-mail is sent when a telegram is received with the polarity defined at this point. Telegrams with another polarity are rejected.
- "Subject": specification of the subject text of the event e-mail (e.g. "Signalling system fault", "Heater frost protection", etc.). The text may be a maximum of 20 characters in length.
- "Contents": specification of the the text contents of the event e-mail. A maximum of 60 characters can be entered. It is not possible to enter a line break or other formatting. The specified contents text is later transmitted to the mail server as 'plain text' in the event e-mail, and is displayed in the same manner, without special formatting, when the message is opened.
- "Recipient": specification of the e-mail address of a recipient of the event e-mail. Up to five recipients can be specified for each e-mail. The event e-mail is sent simultaneously to all the recipients entered.
The standard input format of the address is specified as "local@domain"
(example: "xxx@yyy.de"). The maximum address length is 58 characters.

The contents text of an event e-mail specified in the ETS plug-in is always replaced by an automatic text. The recipient of the event e-mail would always read the following additional note at the end of the contents...

"This message was generated automatically. Date: dd.mm.yyyy Time: hh:mm"

To enable the panel to send e-mails, a valid SMTP mail server (Simple Mail Transfer Protocol) must be entered in the device configuration. The SMTP configuration is carried out in the PC Client software (see chapter 4.3.1. Introduction, installation and program start).

- i** After a device reset (return of mains power supply, programming operation), the panel first initialises the Ethernet interface. e-mails can only be sent when this initialisation operation has been completed (if necessary using DHCP). After a device reset, this is usually possible after 1 minute at the latest.
- i** The panel always sends the text characteristics of an e-mail messages using the system character set set in the ETS plug-in (Windows codepage).

Sending the data values of the datalogger by e-mail message

If the datalogger channel is configured in the ETS plug-in, then the recorded data values can be sent cyclically by e-mail. In this case, the panel prepares the recorded data in a CSV file and sends it to a specified recipient in a standard e-mail. Both the e-mail function and the recipient address can be configured in the ETS plug-in in the parameter group of a datalogger channel. The e-mail is sent automatically each time the configured recording period of the appropriate datalogger channel has elapsed (see chapter 4.2.4.10.1. Datalogger recording). The data forwarded by e-mail thus take only the data values of one recording period into account.

- i In addition to the transmission of the datalogger measurement values by e-mail, the data values can be read out by the PC Client software and saved in a file (see chapter 4.3.1. Introduction, installation and program start).

4.2.4.14 RSS newsfeeds

4.2.4.14.1 Introduction

The panel offers the option of synchronising RSS 2.0 newsfeeds and displaying them on the device monitor. RSS (Really Simple Syndication) is a service on websites, which publishes current contents, often messages headlines or journals (weblogs) at regularly intervals, and makes them available in simple text or image format. The provision of data in the RSS format is termed an RSS feed.

Newsfeeds are usually divided up into various categories by content, which are often shown directly in the title of a feed (e.g. politics, business, lifestyle, etc.). Each newsfeed automatically gives the reader new message contents (feed items). Each feed item consists of a title and contents. The contents can also contain simple images in addition to the text.

The World Wide Web (www) contains countless offers for regular news or report publication. Many providers of these websites make RSS feeds available with the latest reports. Newsfeeds are usually linked directly to the website of a provider and can be localised and displayed using a web browser. The web address of an RSS feed looks very similar to that of a 'normal' website. The Internet also contains many RSS directory services, which considerably simplify the finding of available RSS newsfeeds.

It is possible to configure the RSS newsfeeds accessible in the panel in the PC Client software (see chapter 4.3.1. Introduction, installation and program start). In this way, the panel operator can configure their newsfeed sources independently of the ETS.

At least one valid newsfeed source must be specified in the PC Client software, in order to be able to display newsfeed contents. The panel can make a distinction between up to eight newsfeed sources.

The panel downloads a newsfeed from the provider's website in the form of an XML file. A feed file may have a maximum size of 100 kB. Should a feed be larger - for example, on account of lots of entries - the panel will automatically shorten the contents, thus deleting some news entries, primarily the older ones, completely from the newsfeed.

i The panel can load and display RSS newsfeeds of Version 2.0. Other RSS formats or the alternative "Atom" format cannot be evaluated and displayed by the panel.

4.2.4.14.2 Displaying RSS newsfeeds

Synchronising RSS newsfeeds

The panel allows the evaluation of up to eight different RSS sources. The web address of an RSS source is set using the PC Client software (see chapter 4.3.1. Introduction, installation and program start). The panel polls all the configured RSS sources cyclically and updates the feed contents. The update time can be configured for each RSS source in the RSS settings in the PC Client software, allowing the user to influence the topicality of the displayed messages. In addition 'manual' polling of the RSS newsfeeds is possible directly on the panel (see section "Displaying RSS newsfeeds" below).

- i** For the panel to be able to synchronise the RSS sources cyclically without faults, the LAN connection (Ethernet operation) and, if necessary, the WAN connection (Internet) must be available without interruptions. It is generally advisable to have a suitable flatrate connection (e.g. DSL Flat), in order to keep the telephone and Internet connection costs as low as possible.
- i** The panel automatically synchronises itself with the RSS sources for the first time 2 minutes after a device reset (return of mains power, programming operation). There is no automatic synchronisation before this time has elapsed, meaning that RSS newsfeeds are displayed after a delay after a reset (see next section).
- i** The synchronisation operation always runs in the background. During this time, the panel can be operated normally. Fault-free KNX/EIB communication is also guaranteed. It should be noted that the synchronisation operation may take several seconds, in the case of large contents even several minutes. For this reason, one should wait after each synchronisation until the feed contents can be fully displayed. If the panel is too busy processing the feed data (text parsing, image scaling) that no touch operation is generally possible for a short period, then the "Hourglass icon" appears at the centre of the screen.

Displaying RSS newsfeeds

The operator of the panel can display the contents of the RSS newsfeeds on the device display at any time. To do this, they must open the "Overview of RSS feeds" system page. It is possible to jump to this page by opening the page using a function button.

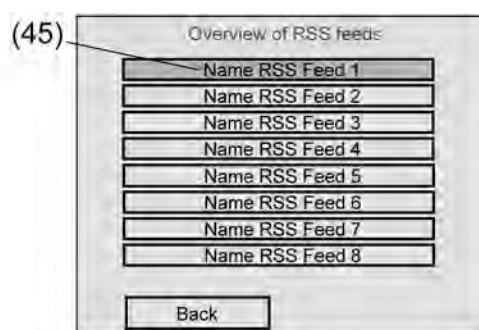

Figure 42: System overview page for RSS newsfeeds

(45) Name of an RSS newsfeed (transmitted by the feed source and thus cannot be edited)

A button is displayed in the overview for each active RSS source (see chapter 4.3.1. Introduction, installation and program start). The title of an RSS newsfeeds transmitted by the RSS source appears as text in the buttons (45), thus clearly identifying the source of the messages.

An RSS button shows the text "No data loaded", when the panel was unable to synchronise the feed contents (e.g. server of the RSS source is offline, Internet connection failure, incorrect URL specified) or, for example, no data has yet been polled after a device reset.

As soon as the operator taps an RSS button, the panel switches to the inbox display page of the appropriate RSS newsfeed (figure 43).

- i** Pressing an RSS button for a long time (> 5 s) causes the panel to synchronise itself automatically with the appropriate RSS source. This allows manual synchronisation in addition to the cyclic news updates by the panel. It should be noted that the synchronisation operation may take several seconds, in the case of large contents even several minutes. For this reason, one should wait after each synchronisation until the feed contents can be fully displayed.

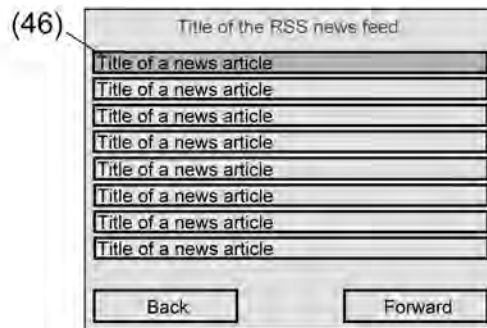

Figure 43: Display page of an RSS newsfeed

(46) "Read" button of a news item

The RSS newsfeed display page contains various buttons for news items. The title of a news item is shown within a button.

Eight news items are displayed on each display page. An RSS newsfeed may consist of multiple display pages, according to how many news items this feed has. Pressing the "Forward" and "Back" buttons allows navigation between the display pages, allowing the opening of additional messages. Pressing "Back" on the first display page switches back to the RSS overview page.

The panel downloads a newsfeed from the provider's website in the form of an XML file. A feed file may have a maximum size of 100 kB. Should a feed be larger - for example, on account of lots of entries - the panel will automatically shorten the contents, thus deleting some news entries, primarily the older ones, completely from the newsfeed. For this reason, the display of news items on the display pages is limited.

When the "Read" button is pressed (46), this opens the Read mode of a news item. In Read mode, the panel displays the contents of a news item.

An item usually consists of a short text, describing the news headline. Items may also contain images. For this reason, the contents display in Read mode may vary between "Text only" (figure 44) or "Text and image" (figure 45).

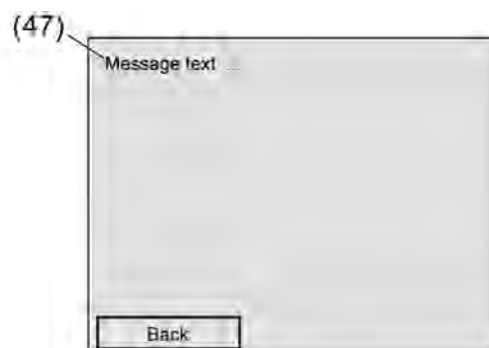

Figure 44: Display of a feed item with 'Text only'

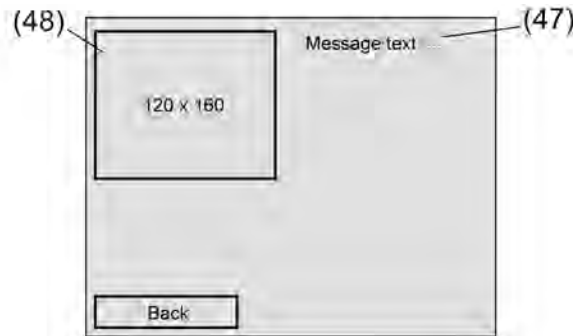

Figure 45: Display of a feed item with 'Text and image'

The differences between "Text" and "Text and image" in plain text...

- Only text in the feed item:
The panel displays the news text (47) without special formatting in Read mode (HTML elements are removed automatically). It is displayed in up to 9 lines over the entire width of the screen.
 - Text and image(s) in the feed item:
If the feed item contains a image, then a section of the panel screen (48) is reserved, which is 120 x 160 pixels in size. The image is shown in the centre of this cut-out. Should the downloaded image be larger than the reserved image cut-out, then it will be scaled down, maintaining the page ratio. If it is smaller or the same size, it is displayed in the original size. Only one image is ever displayed, that which was found first in the contents of the feed item. Additional items in the feed item are ignored.
The message text (47) is displayed here over 9 lines without any special formatting. At the top of the screen, the text wraps around the image area. Then it is output over the entire width of the screen.
- i** If the text contents of a feed item is so large that it cannot be displayed on the 9 lines of a screen page, the the panel will extend read mode by another page. The "Forward" and "Back" buttons allow navigation between the pages. Pressing "Back" on the first page exits Read mode. If the text is longer and cannot be displayed on two pages, then the panel automatically cuts off the text contents at the end of the second page. Line breaks in the text are evaluated.
On the second page, the image is also display, assuming that the feed item contains an image.
 - i** Links in the text to other sites are display in normal formatting. The links are inactive.
 - i** If a feed item contains images, the following should be noted:
 - Only the following formats can be displayed: JPG (not progressive), GIF (animation not shown).
 - The panel first loads the text of the item and then the image. In particular, large images can cause the loading of graphic data to take time, meaning that only the text is displayed and an "X" icon in the image area. Only when the panel has loaded the image and, if necessary, scaled it, is the image shown.
 - i** The Read mode of a feed item can only be opened when the panel has fully loaded all the items of the appropriate RSS newsfeeds. If the loading operation has not be completed, then, when the "Read" button of an item is tapped, the panel will not react (figure 43). In this case, it is advisable to wait until the loading operation, which always takes place in the background, has been completed.
 - i** The panel displays feed items in the order in which they were transmitted from the RSS server.

General information on displaying the text contents of RSS newsfeeds

The character set of the panel is Windows codepage-orientated. Loaded RSS newsfeeds are usually encoded as ISO codepage or UTF-8. The panel converts the incoming texts, including special characters (e.g. Ää Öö Üü ß) to the system character set selected in the ETS plug-in. When an incoming character is not contained in the system character set, then this character cannot be display and is labelled with "?" in the device. This may occur, for example, when a panel is set to the Western European character set 1252 and e-mails are received from the Eastern European area (e.g. ISO 8859-2). As these two zones are not intercompatible, there may be characters which cannot be displayed.

It takes a while to convert the character sets, also influencing the loading operation of RSS newsfeeds.

4.2.4.15 Group addresses

On starting, the plug-in transfers all the currently defined group addresses from the ETS project database and display them in the tree structure in the "Group addresses" node. In addition, the plug-in can also use "internal group addresses", which are not transmitted to the bus. Internal group addresses can be created using the context menu in the node of the same name.

Group addresses and internal group address can be linked to the communication objects in the same way using mouse by "drag and drop" or using the context menu (click the right mousebutton on a communication object). If the connection is to be created using the context menu, a dialog opens in which a group address can be created.

The use of internal group addresses is advisable when, for example, the output of a timer switch should only be connected to the control input of a multiplexer and no telegram is to be transmitted to the bus.

4.2.4.16 Options of the ETS plug-in

The project planning and programming of the panel takes place using the ETS with the installed plug-in. This plug-in gives the project planner various options, which can be opened in the menu under "Setting -> Options".

Table:

The "Table" tab can be used to set various options, which affect the tables on the right-hand side of the plug-in project planning desktops. These can be changed according to personal taste.

Options:

The "Options" tab can be used to specify at which intervals the plug-in saved modified data to a backup file (Auto Save file). A backup file can be created independently of this using the "Device" menu.

The option "Automatically assign page / Display element designation" specifies whether, when the designation of an element is changed, the text shown on the screen is changed automatically. In addition, the saved data can be checked for internal contradictions or other errors. This database test only comprises the data processed by the project planning software. This does not affect the ETS database.

The settings under the item "Speed optimisation" specify whether the project software should save your data to the ETS database or to a separate file. In particular, when using wallpapers, the use of a separate file can increase speed considerably. However, these separate files but be copied manually during a data backup or on transferring the project data to another PC. These options can only be set in conjunction with the ETS 3. In ETS2, the project planning data is always saved to a separate file.

Hardware:

The values in the fields "Firmware version" and "Firmware file" are solely for information purposes. If necessary, the project planning software automatically loads the current firmware to the panel. During commissioning, the PC first determines which data is currently loaded in the device. To keep the programming time as short as possible, only the changed data is transferred. The option "Transfer all on next download" loads the complete application without any time optimisation. This may increase the time required for commissioning considerably. It is should not be necessary to activate these options. If problems occur during commissioning, it may be possible to solve them with this option.

Display elements:

The options on the "Display elements" tab allow standardised positioning and design of the display elements when creating your own screen pages.

4.2.5 Parameters

Description	Values	Comment
<input type="checkbox"/> General		
Mounting orientation	Landscape Portrait	This parameter specifies the alignment of the display. In the "Landscape" setting, an area of 320 x 240 pixels is available. In the "Portrait" setting, 240 x 320 pixels are available. If this parameter is changed, then all the planned information is lost.
Automatically to Start page	No 2 min 5 min 10 min 30 min 60 min	If the panel is not operated for longer than the time defined here, then the display automatically jumps back to the Start page. The "No" setting causes the panel to stay on the last set screen page.
Start page	[1] Page – Page ... List of all projected user pages	This parameter specifies which screen page is shown on initialisation.
System colour scheme	Scheme 1 ... List of the defined colour schemes	All the screen pages, which do not have their own colour scheme, use the colours of the system colour scheme defined here.
Length of acoustic signal	10 s 30 s 1 min 3 min 5 min	Time for which the internal piezo buzzer of the panel is switched on when a fault message arrives. When this time has elapsed, it is switched off automatically.
External object for acoustic signal	No Yes	If this parameter is set to "Yes", the object "Acoustic note [sound output]" is displayed. This object can be used to switch on ("1") and switch off ("0") the internal piezo buzzer of the panel as required using switching telegrams. <p>i The acoustic messages generated automatically by the panel (e.g. fault message or 'Unarmed after alarm' from the signalling system) cannot be switched off by the object.</p>
Compare timer switch on change	No Yes	The "Yes" setting means that when one or more switching times are changed,

there will be a switching time review. When a switching time is set, and which is before the current time, the panel checks whether a telegram has now been transmitted for the affected timer switch channel. If this is not the case, the telegram of this switching time is repeated and is thus executed immediately.

If the parameter is set to "No", the switching time in the past is not executed until the following day.

Scroll bar

Always show
Always hide
Automatic

The panel can display a scroll bar on the right hand side of the screen, using which it is possible to navigate between multiple linked pages or different display elements. With the "Automatic" setting, the scroll bar is only shown when there is a previous or next page available, meaning that page navigation is required. Otherwise the scroll bar is hidden on a page created by the project planner.

With the "Always hide" setting, the scrollbar cannot be seen on any screen page. In this case, it is not possible to navigate between the screen pages using the scroll bar.

With the "Always show" setting, the scrollbar can be seen on every screen page. It takes up space, even if no page navigation is planned.

On certain system pages, the scroll bar is not shown for reasons of clarity and navigation.

i With the "Always show" and "Automatic" settings, the scroll bar can also be seen on some system pages.

Telegram acknowledge

Required for status display

Not required for status display

A display element usually shows the current value of a communication object (e.g. ON or OFF). If the communication object does not possess a valid value, then the display element will just show a line of dashes "-----" rather than the value in the display element.

This parameter allows you to use the "Not required for status display" parameter to show a value sent by the panel, even without a valid acknowledgement. Caution: this setting may cause the panel to display values which deviate from the real status in the KNX/EIB system.

With the setting "Required for status display", an external acknowledgement of a sent telegram is always required until the panel displays a valid value in the display element.

Status poll delay after start (x 5 ms)	50... 60 ...1000	The waiting time is defined here until the panel to read out values of other communication objects during a status poll after initialisation. This parameter gives other devices time to initialise.
Delay between status polls (x 5 ms)	10... 20 ...100	The waiting time between individual panel status polls is defined here. This parameter helps to limit the bus load during initialisation.
Delay between light scene outputs (x 5 ms)	10... 20 ...100	Here, the time is defined which the panel waits between the individual telegrams of a light scene. This parameter helps to limit the bus load when opening light scenes.
Transmit limit values on initialisation	No Yes	In the "Yes" setting, the device transmits the statuses of the limit value objects, as soon as they have a valid value after initialisation. In the "No" setting, the device only sends the limit value objects on over or undershoots, i.e. when the appropriate value changes.
System character set	Eastern Europe (1250) Cyrillic (1251) Western Europe (1252) Greek (1253) Turkish (1254)	In order to display texts in various languages on the screen, and, if necessary, input them, you need to set the character set (codepage) of the device and the assignment of the on-screen keyboard. This parameter specifies the character set used for all the system pages. In addition, each page created by the project planner can be configured separately with its own "character set". This configuration is then possible in each parameter node of a page. There the system character set ("System" setting) can also be used as a default setting, if, for example, the same character set is always used. However, it is also possible to use different character sets for pages.
Keyboard layout	German (Germany) English (United Kingdom)	The parameter specifies the arrangement of various characters within the on-screen keyboard
Open page via object	No Yes	Each screen page of the panel (pages created by the project planner and,

optionally, various system pages) can be opened via a 1 byte KNX/EIB object. If a page is to be opened using the object, this parameter must be set to "Yes. In this case the object "Open page " becomes visible.

Password for PC Client software **12345**

The communication connection between the PC Client software and the panel is protected by a password. This parameter allows the input of a password of maximum 16 characters. The box can also be left empty meaning that communication between the PC Client software and the panel takes place without password protection. The password entered in the PC Client software and the panel must be identical. The password is encrypted in the communication connection, meaning that it is safe from sabotage.

LCD lighting

LCD lighting

Continuous operation
On actuation
On actuation or switching object

In the "Continuous operation" setting, the background lighting is switched on at maximum brightness. It cannot be switched, either via the device or the bus.

In the "On actuation" setting, the background lighting is adjusted to the set basic brightness value when idle. This means that the background lighting may even be switched off. As soon as the device is operated, the lighting returns to maximum brightness. After the set "LCD lighting length" time, the backlighting returns to the set basic level of brightness.

In the "On actuation or switching object" setting, the lighting is adjusted to the set basic brightness value when idle. When the touch screen is actuated or when a switching value is received via the "Lighting object" communication object, the lighting temporarily switches to maximum brightness for the configured "LCD lighting length". In addition, the backlighting can also be switched off at any time via the object.

LCD lighting length **1 min**
3 min
5 min
10 min
15 min
30 min

If the panel is not operated for longer than this time, the backlighting of display switches back to basic brightness.

LCD lighting on	0 telegram 1 telegram	The telegram polarity of the "Lighting object" object is defined here. This parameter is only visible on "LCD lighting = On actuation or switching object".
Basic brightness	Off Dark Light	The basic level of brightness can be configured here. The settings "OFF", "Dark" and "Light" are available. When the basic level of brightness is set to "Light", the display is always at maximum brightness for all the settings of the "LCD lighting" parameter.
□↵ Date / Time		
Date display format	DD.MM.YYYY DD.MM.YY MM.DD.YY MM.DD.YYYY	The parameter defines the format for displaying the date. "DD" stands for the day, "MM" for the month and "YY" or "YYYY" for the year.
Time display format	12 hours 24 hours	The panel can either display the time in 24 hour format or in 12 hour format (with "AM" and "PM").
Send date	DO not transmit Transmit cyclically Transmit on request Transmit on request and cyclically	The transmission behaviour of the "Date object" parameter is defined by this parameter. "Do not transmit" setting: the panel does not automatically transmit the date to the bus. In such cases, there is no synchronisation of external bus subscribers. "Transmit cyclically" setting: the panel transmits the date to the bus cyclically. The parameter "Cycle time for date transmission" defines the regularity of transmission. "Transmit on request" setting: in this configuration, there is an additional 1 bit communication object with the name "Request date / time through external device" available. When the panel receives a switching telegram from another KNX/EIB bus subscriber via this object, it evaluates the telegram as a request and transmits the current date to the bus as a response. "Transmit cyclically and on request" setting: this setting is a combination of the two single configurations described above.
Transmit cycle time for date	1 / minute 1 / hour 1 / day	This parameter specifies the transmission regularity of the automatic transmission of the date telegram by the

		panel. Only visible when cyclical date transmission is configured.
Send time	DO not transmit Transmit cyclically Transmit on request Transmit on request and cyclically	The transmission behaviour of the "Time object" parameter is defined by this parameter. "Do not transmit" setting: the panel does not automatically transmit the time to the bus. In such cases, there is no synchronisation of external bus subscribers. "Transmit cyclically" setting: the panel transmits the time to the bus cyclically. The parameter "Cycle time for time transmission" defines the regularity of transmission. "Transmit on request" setting: in this configuration, there is an additional 1 bit communication object with the name "Request date / time through external device" available. When the panel receives a switching telegram from another KNX/EIB bus subscriber via this object, it evaluates the telegram as a request and transmits the current time to the bus as a response. "Transmit cyclically and on request" setting: this setting is a combination of the two single configurations described above.
Transmit cycle time for time	1 / minute 1 / hour 1 / day	This parameter specifies the transmission regularity of the automatic transmission of the time telegram by the panel. Only visible when cyclical time transmission is configured.
Date / time request by	0 telegram 1 telegram	The telegram polarity of the "Request date / time using external object" object can be configured at this point. This parameter is only visible when the request ("Send date" or "Send time") is enabled.
Automatic time setting	No According to European standard As switching object	The "Automatic time setting" parameter can specify in which form the internal clock of the panel carries out the change from summer to winter time. The "According to European standard" setting means that the panel automatically sets the time one hour ahead from the last Sunday in March to the last Sunday in October, i.e. switches to summer time. The setting "As switching object" activates the "Automatic time setting" communication object. When this object has the value "1", the panel uses

summer time (+1 hr.). When it has the value "0", the panel uses the unchanged normal time. During initialisation, the "Automatic time change" object transmits a single read request to the bus (status poll object flag = yes). The effect of the "No" setting is that the panel does not automatically switch from summer to winter time, for example, because a higher-level clock has already transmitted appropriately corrected date and time information.

Request date / time

No
Yes

The panel can use the "Request date / time" object to transmit an enquiry telegram to the bus, in order to synchronise the internal clock. In the "Yes" setting, this communication object transmits a request telegram after each device initialisation and then regularly once a day at 4:00 a.m.. The response of the current time and date is then expected via the objects "MasterDate" and "MasterTime".

Request by

0 telegram
1 telegram

This parameter defines the telegram polarity of the telegram which the panel transmits to the bus as a synchronisation request. This parameter is only visible on "Request date / time = Yes".

Comparison with external clock

No
Date & time
Date
Time

If a higher-level clock (master clock) regularly transmits the current time and / or the current date, the panel can synchronise the internal clock automatically using telegrams from the higher-level clock. In this case, the "MasterTime and MasterDate" objects can be shown according to the setting of this parameter. This parameter is only visible on "Request date / time = No".

Download behaviour

Overwrite light scene names, delete values

No
Yes

After commissioning, the operator can make various settings directly on the panel while the system is running. These also include the names and settings of light scenes. During first commissioning of a device with new project planning data, these parts must be overwritten. For this, set the parameter "Overwrite light scene name, clear values" to "Yes". After first

<p>Overwrite all switching times of the timer switch</p>	<p>No Yes</p>	<p>download, the parameter can be reset to "No" to maintain any changes made by the user in subsequent programming operations.</p>
<p>Overwrite limit values</p>	<p>No Yes</p>	<p>After commissioning, the operator can make various settings directly on the panel while the system is running. These also include the switching times of the internal timer switch. During first commissioning of a device with new project planning data, these parts must be overwritten. For this, set the parameter "Overwrite all switching times of the timer switch" to "Yes". After first download, the parameter can be reset to "No" to maintain any changes made by the user in subsequent programming operations.</p> <p>i The parameter "Overwrite all switching times of the timer switch" should be set to "Yes", if the switching times predefined in the ETS plug in should be reloaded into the panel after each programming operation.</p>
<p><input type="checkbox"/> Pages -> [Page designation] - [Page overview]</p>		
<p>Designation</p>	<p>[Page]</p>	<p>A page designation can be entered here, which is only displayed in the tree structure within the ETS plug-in.</p>
<p>Display heading</p>	<p>No Yes</p>	<p>A definition is set here as to whether the page heading is displayed on the screen.</p>
<p>Heading</p>	<p>[Page]</p>	<p>The page heading can be entered here to be displayed on the screen. Only visible on "Display heading = Yes".</p>

<p>Password level</p>	<p>No password protection Password level 1 Password level 2 Password level 3 Password level 4</p>	<p>If a password level is set here, then the user must enter the correct password to open the page, if the previous page has a lower password level.</p>
<p>Wallpaper</p>	<p>No presetting</p>	<p>Pressing "..." opens the "Image list" dialog using which new images are added to the project planning and existing wallpapers can be selected.</p>
<p>Colour scheme</p>	<p>System ... List of the defined colour schemes</p>	<p>The colour scheme used on the page can be set here. With the presetting "System", the page uses the system colour scheme selected in the "General" parameter group.</p>
<p>Character set</p>	<p>System Eastern Europe (1250) Cyrillic (1251) Western Europe (1252) Greek (1253)</p>	<p>The character set used on the page can be set here. With the presetting "System", the page uses the system character set selected in the "General" parameter group.</p>
<p>Display status line</p>	<p>No Yes</p>	<p>This parameter defines whether the status line is displayed on the top edge of the screen.</p>
<p>Previous page</p>	<p>--- ... List of created pages</p>	<p>If the scroll bar is displayed automatically or continuously, then the navigation sequence can be defined here. The double arrows of the scroll bar allow backwards scrolling on the defined pages.</p>
<p>Next page</p>	<p>--- ... List of created pages</p>	<p>If the scroll bar is displayed automatically or continuously, then the navigation sequence can be defined here. The double arrows of the scroll bar allow forwards scrolling on the defined pages.</p>
<p><input type="checkbox"/> Page -> [Display element designation] - [Display element function] -> General</p>		
<p>Designation</p>	<p>[Display element]</p>	<p>A display element designation can be entered here, which is only displayed in the tree structure within the ETS plug-in.</p>
<p>Text</p>	<p>[Display element]</p>	<p>The display text of the display element is specified here. The text appears within the display element on the screen.</p>

Width	100	This parameter specifies the width of the display element in the screen page in pixels. The settable value depends on the installation position of the panel and the position of the display element.
Height	21	This parameter specifies the height of the display element in the screen page in pixels. The settable value depends on the installation position of the panel and the position of the display element.
X position	10	This parameter specifies the X position of the display element in the screen page in pixels. The settable value depends on the installation position of the panel and the size of the display element.
Y position	70	This parameter specifies the Y position of the display element in the screen page in pixels. The settable value depends on the installation position of the panel and the size of the display element.
Horizontal text alignment	Left-align Centred Right-align User-defined	This parameter defines the horizontal arrangement of the display element text within the display element. In the "User-defined" setting, an additional parameter is displayed for precise positioning.
X position of the text	1	The alignment of the display text within a display element is specified here. The settable value depends on the width of the display element.
Vertical text alignment	Top Centred Bottom	This parameter defines the vertical arrangement of the display text within the display element.
Icon	No presetting	Pressing "..." opens the "Image list" dialog using which new images are added to the project planning and existing images as icons for a display element can be selected.

Horizontal icon alignment	Left-align Centred Right-align User-defined	This parameter defines the horizontal arrangement of the icon within the display element. In the "User-defined" setting, an additional parameter is displayed for precise positioning.
X position of the icon	0	The horizontal alignment of the icon within a display element is specified here. The settable value depends on the width of the display element.
Vertical icon alignment	Top Centred Bottom User-defined	This parameter defines the vertical arrangement of the icon within the display element. In the "User-defined" setting, an additional parameter is displayed for precise positioning.
Y position of the icon	0	The vertical alignment of the icon within a display element is specified here. The settable value depends on the height of the display element.
Frame of the inactive display element	Always hide Always show Only show focussed	The frame of an inactive display element can be show or hidden. The setting "Only show focussed" makes it clear which display element is selected using the scroll bar.
Wallpaper	Transparent Opaque	Here it is defined whether the background of a display element is shown transparently or whether it is opaque. In conjunction with special wallpapers or level displays, the background of a display element can, for example, be transparent.
Element selectable	No Yes	Display elements which cannot be selected cannot trigger a function. They are only for display purposes and do not possess any operational settings.
Touch operation	One-click operation Two-click operation	The reaction of the panel to the actuation of a display element is specified here. One-click operation means that tapping the display element immediately executes the function of the corresponding function button 1. Two-click operation means that tapping the display element displays the function buttons, but no function is executed immediately.

		This parameter is only visible on "Element selectable = Yes".
Hide function buttons	No Yes	This parameter specifies whether the appropriate function buttons are visible for a selected element with one-click operation. If all the function keys are visible, then additional buttons of the element can be operated after clicking the display element and automatic execution of the function of button 1. This parameter is only visible on "Element selectable = Yes" and "Touch operation = One-click operation".
<p>☐ Page -> [Display element designation] - [Display element function] -> Function</p>		
Function display	Text display Switching Dimming Blind Value Light scene Date Time ASCII text Datalogger display Access check Restraint Operating mode switch Collective feedback Dimmer actuator load type	Specification of the display function of a display element. Depending on this setting, additional parameters and, if possible, additional communication objects are displayed. With the "Text display" setting, the display element is only used to display a static text or an icon on the screen.
<p><i>For "Switching" display function...</i></p>		
Status display	As text As icon	The display element can display either texts of status images from the image list to display the status.
Image text for 1	[On]	Here, the text can be entered to be displayed in the display element on status "1" (switched on). This parameter is only visible with "Status display = as text".
Image text for 0	[Off]	Here, the text can be entered to be displayed in the display element on status "0" (switched off). This parameter is only visible with "Status display = as text".
Icon for 1	No presetting	Here, an icon can be configured using the image list to be displayed in the

		display element on status "1" (switched on). This parameter is only visible with "Status display = as icon".
Icon for 0	No presetting	Here, an icon can be configured using the image list to be displayed in the display element on status "0" (switched off). This parameter is only visible with "Status display = as icon".
Value alignment	Left-align Centred Right-align User-defined	This parameter defines the horizontal arrangement of the status text or icon within the display element. In the "User-defined" setting, an additional parameter is displayed for precise positioning.
X position of the value	1	The alignment of the status text of icon within a display element is specified here. The settable value depends on the width of the display element.
<i>For "Dimming" display function...</i>		
Display	Switching state Brightness value	Definition of whether the set switching state or the brightness value is display using the dimming function. Various object types and parameters are available depending on this function.
Status display	As text As icon	The display element can display either texts of status images from the image list to display the status. Only visible on "Display = Switching state".
Image text for 1	[On]	Here, the text can be entered to be displayed in the display element on status "1" (switched on). This parameter is only visible with "Status display = as text" and "Display = switching state".
Image text for 0	[Off]	Here, the text can be entered to be displayed in the display element on status "0" (switched off). This parameter is only visible with "Status display = as text" and "Display = switching state".

Icon for 1	No presetting	<p>Here, an icon can be configured using the image list to be displayed in the display element on status "1" (switched on).</p> <p>This parameter is only visible with "Status display = as icon" and "Display = switching state".</p>
Icon for 0	No presetting	<p>Here, an icon can be configured using the image list to be displayed in the display element on status "0" (switched off).</p> <p>This parameter is only visible with "Status display = as icon" and "Display = switching state".</p>
Time base between switching and dimming	10 ms 100 ms 1 s	<p>This parameter specifies the time base for the time from which the panel detects long actuation for dimming. For improved accuracy, we recommend selecting a small time base with a large time factor.</p> <p>This parameter only has a function when the function "Dimming function of the display element" has been selected for function button 1.</p>
Time factor between switching and dimming	0... 6 ...127	<p>This parameter specifies the time factor for the time from which the panel detects long actuation for dimming. For improved accuracy, we recommend selecting a small time base with a large time factor.</p> <p>This parameter only has a function when the function "Dimming function of the display element" has been selected for function button 1.</p>
Value display type	0 ... 100% 0 ... 255	<p>The display of the numeric value is displayed here.</p> <p>This parameter is only visible on "Display = Brightness value".</p>
Status display	As value As bar graph	<p>The status can either be displayed as a numeric value or as a bar diagram.</p> <p>Only visible on "Display = Brightness value".</p>
Value alignment	Left-align Centred	<p>This parameter defines the horizontal arrangement of the status text, value or icon within the display element. In the</p>

	Right-align User-defined	"User-defined" setting, an additional parameter is displayed for precise positioning.
X position of the value	1	The alignment of the status text, value or icon within a display element is specified here. The settable value depends on the width of the display element.
<i>For "Blind" display function...</i>		
Status display	As text As icon	The display element can display either texts of status images from the image list to display the status.
Image text for blind up	[Up]	Here, the text can be entered to be displayed in the display element on the status "Blind up". This parameter is only visible with "Status display = as text".
Image text for blind down	[Down]	Here, the text can be entered to be displayed in the display element on the status "Blind down". This parameter is only visible with "Status display = as text".
Icon for blind up	No presetting	Here, an icon can be configured using the image list to be displayed in the display element on the status "Blind up". This parameter is only visible with "Status display = as icon".
Icon for blind down	No presetting	Here, an icon can be configured using the image list to be displayed in the display element on the status "Blind down". This parameter is only visible with "Status display = as icon".
Time base between short/long-time operation	10 ms 100 ms 1 s	This parameter specifies the time base for the time from which the panel detects long actuation. For improved accuracy, we recommend selecting a small time base with a large time factor. This parameter only has a function when the function "Blind function of the display element" has been selected for function button 1.

Time factor between short/long-time operation	0... 3 ...127	<p>This parameter specifies the time factor for the time from which the panel detects long actuation. For improved accuracy, we recommend selecting a small time base with a large time factor.</p> <p>This parameter only has a function when the function "Blind function of the display element" has been selected for function button 1.</p>
Slat adjust time, basic	10 ms 100 ms 1 s	<p>This parameter specifies the time base for the time required for complete rotation of the slats. For improved accuracy, we recommend selecting a small time base with a large time factor.</p> <p>This parameter only has a function when the function "Blind function of the display element" has been selected for function button 1.</p>
Slat adjust time, factor	0... 6 ...127	<p>This parameter specifies the time factor for the time required for complete rotation of the slats. For improved accuracy, we recommend selecting a small time base with a large time factor.</p> <p>This parameter only has a function when the function "Blind function of the display element" has been selected for function button 1.</p>
Value alignment	Left-align Centred Right-align User-defined	<p>This parameter defines the horizontal arrangement of the status text or icon within the display element. In the "User-defined" setting, an additional parameter is displayed for precise positioning.</p>
X position of the value	1	<p>The alignment of the status text or icon within a display element is specified here. The settable value depends on the width of the display element.</p>
<i>For "Value" display function...</i>		
Value display	<p>DPT 9.001 ... 9.021 (2 byte value)</p> <p>DPT 5.001 ... 5.004 (1 byte relative value)</p> <p>DPT 14.000 ... 14.079 (4 byte IEEE float)</p>	<p>Defines the value range and the data format of the corresponding communication object. Additional parameters are displayed depending on this setting</p>

	DPT 8.001 (2 byte counter with plus/minus sign)	
	DPT 7.001 (2 byte counter)	
	DPT 13.001 (4 byte counter with plus/minus sign)	
	DPT 12.001 (4 byte counter)	
	DPT 6.010 (1 byte counter with plus/minus sign)	
	DPT 5.010 (1 byte counter)	
Display format	0 ... 255 0 ... 100% 0...360° User-defined Bit-orientated	The display format of the value is defined here. This parameter is only visible with "Value display = DPT 5.001 ... 5.004(1 byte)".
Status display	As value As bar graph	With the format DPT 5.001 ... 5.004, the status can either be displayed as a numeric value or as a bar diagram. This parameter is only visible with "Value display = DPT 5.001 ... 5.004(1 byte)" but not on "Display format = user-defined" or "Display format = bit-orientated".
Status display	As text As icon	With bit-orientated evaluation of the format DPT 5.001 ... 5.004, the status can be displayed either as display text or as an icon display. This parameter is only visible with "Value display = DPT 5.001 ... 5.004 (1 byte)" and "Display format = bit-orientated".
Image text for 0	[Off]	Here, the text can be entered to be displayed in the display element on bit status "0" (switched off). This parameter is only visible with "Status display = as text" and "Display format = bit-orientated".
Image text for 1	[On]	Here, the text can be entered to be displayed in the display element on bit status "1" (switched on). This parameter is only visible with "Status display = as text" and "Display format = bit-orientated".

Icon for 0	No presetting	<p>Here, an icon can be configured using the image list to be displayed in the display element on bit status "0" (switched off).</p> <p>This parameter is only visible with "Status display = as icon" and "Display format = bit-orientated".</p>
Icon for 1	No presetting	<p>Here, an icon can be configured using the image list to be displayed in the display element on bit status "1" (switched on).</p> <p>This parameter is only visible with "Status display = as icon" and "Display format = bit-orientated".</p>
Bit to be evaluated	0...7	<p>The bit, to be evaluated to display a bit-orientated status display in the 1 byte value, should be selected here.</p> <p>This parameter is only visible in the data format DPT 5.001 ... 5.004 and "Display format = bit-orientated".</p>
Offset	0	<p>This parameter can be used to adapt the value of the communication object to the required format using a static offset (positive or negative).</p>
Amplification	1	<p>This parameter can be used to adapt the value of the communication object to the required format using reinforcement (multiplier).</p>
Format	#####.#	<p>This parameter can be used to specify the format of the displayed value. Pressing "..." can set the format using an editor, using which the predefined standard format can be changed through manual inputs.</p>
Unit	% List of predefined units	<p>This parameter can be used to specify a unit for the format DPT 5.001 ... 5.004. The unit is displayed immediately behind the display value.</p> <p>This parameter is invisible with "Value display = DPT 5.001 ... 5.004 (1 byte)" and in conjunction with "Value format = bit-orientated".</p>
Value alignment	Left-align Centred Right-align User-defined	<p>This parameter defines the horizontal arrangement of the status value within the display element. In the "User-defined" setting, an additional parameter</p>

		is displayed for precise positioning.
X position of the value	1	The alignment of the status value within a display element is specified here. The settable value depends on the width of the display element.
Limit value monitoring	No Yes	Two limit values (upper limit value / lower limit value) are available for each value display, and can be configured using additional parameters. This parameter is invisible in the bit-orientated display format (DPT 5.001 ... 5.004).
Upper limit value	No Yes	The upper limit value can be deactivated or activated here.
Value	670760.96	Definition of the upper limit value. The value range refers to the data type defined in the "Value display" parameter.
Hysteresis	0	Specification of the hysteresis of the limit value. The hysteresis must be entered taking the value range used into account.
Limit value changeable	No Yes	This parameter defines whether the user may change the limit value on the panel or using remote control (PC Client software).
Behaviour on exceeding limit value	No action 1 telegram 0 telegram	The limit value object can transmit a switching telegram settable here when the upper limit value is exceeded.
Behaviour when upper limit value - hysteresis not reached	No action 1 telegram 0 telegram	The limit value object can transmit a switching telegram settable here when the upper limit value is undershot, minus the hysteresis.
Transmit delay	No delay 1 s 3 s 5 s 10 s 15 s 30 s	A delay time can be set to reduce the telegram traffic or 'debounce'.

	<ul style="list-style-type: none"> 1 min 3 min 5 min 10 min 15 min 30 min 60 min 	
Lower limit value	<ul style="list-style-type: none"> No Yes 	The lower limit value can be deactivated or activated here.
Value	-671088.64	Definition of the lower limit value. The value range refers to the data type defined in the "Value display" parameter.
Hysteresis	0	Specification of the hysteresis of the limit value. The hysteresis must be entered taking the value range used into account.
Limit value changeable	<ul style="list-style-type: none"> No Yes 	This parameter defines whether the user may change the limit value on the panel or using remote control (PC Client software).
Behaviour on not reaching limit value	<ul style="list-style-type: none"> No action 1 telegram 0 telegram 	The limit value object can transmit a switching telegram settable here when the lower limit value is undershot.
Behaviour on exceeding lower limit value + hysteresis	<ul style="list-style-type: none"> No action 1 telegram 0 telegram 	The limit value object can transmit a switching telegram settable here when the lower limit value is exceeded plus the hysteresis.
Transmit delay	<ul style="list-style-type: none"> No delay 1 s 3 s 5 s 10 s 15 s 30 s 1 min 3 min 5 min 10 min 15 min 30 min 60 min 	A delay time can be set to reduce the telegram traffic or 'debounce'.

For "Light scene" display function...

Value alignment	Left-align Centred Right-align User-defined	This parameter defines the horizontal arrangement of the status light scene number within the display element. In the "User-defined" setting, an additional parameter is displayed for precise positioning.
-----------------	---	---

X position of the value	1	The alignment of the status light scene number within a display element is specified here. The settable value depends on the width of the display element.
-------------------------	----------	--

For "Date" display function...

Source	Internal EIB	The displayed date is derived either from the internal real time clock of the panel or from an additional communication object, i.e. from the KNX/EIB.
--------	------------------------	--

Value alignment	Left-align Centred Right-align User-defined	This parameter defines the horizontal arrangement of the date display within the display element. In the "User-defined" setting, an additional parameter is displayed for precise positioning.
-----------------	---	--

X position of the value	1	The alignment of the date display within a display element is specified here. The settable value depends on the width of the display element.
-------------------------	----------	---

For "Time" display function...

Source	Internal EIB	The displayed time is derived either from the internal real time clock of the panel or from an additional communication object, i.e. from the KNX/EIB.
--------	------------------------	--

Offset [hours]	-12... 0 ...12	To adjust the time to various timezones, the time can be corrected by a static hour offset here.
----------------	-----------------------	--

Value alignment	Left-align Centred Right-align User-defined	This parameter defines the horizontal arrangement of the time display within the display element. In the "User-defined" setting, an additional parameter
-----------------	---	--

is displayed for precise positioning.

X position of the value **1**

The alignment of the time display within a display element is specified here. The settable value depends on the width of the display element.

For "ASCII text" display function...

Length of the ASCII text **1...14**

This setting allows shortening of the received texts for the display.

Value alignment Left-align
 Centred
 Right-align
 User-defined

This parameter defines the horizontal arrangement of the text display within the display element. In the "User-defined" setting, an additional parameter is displayed for precise positioning.

X position of the value **1**

The alignment of the text display within a display element is specified here. The settable value depends on the width of the display element.

For "Datalogger display" display function...

Value alignment Left-align
 Centred
 Right-align
 User-defined

This parameter defines the horizontal arrangement of the graphic display within the display element. In the "User-defined" setting, an additional parameter is displayed for precise positioning.

i The diagram size (graphic display) is directly affected by the size of the display element. Here, the minimum size should be maintained, according to the information shown and the scaling of the axes. If the minimum size is undershot, then it will not be possible to show the diagram on the panel display. In this case, the appropriate display element is filled with a cross.

X position of the value **1**

The alignment of the graphic display within a display element is specified here. The settable value depends on the width of the display element.

Display diagram heading	Yes No	The datalogger diagram can be overwritten with text within the display element. The decision to display the heading or not is taken here.
Diagram heading	[Heading]	The heading of the datalogger diagram in the display element is specified here. This parameter is only visible when the heading is to be displayed.
Display legend	Yes No	A datalogger diagram can display the measured values of up to two datalogger channels in curve format. Each curve is displayed in its own colour. This parameter enables the legend display, thus displaying the curve names (separately configurable) on the bottom edge of the display element, which are assigned to the curve colours. This allows better identification of the curves.
Curve 1 / 2: Datalogger channel	--- ... Selection list of the datalogger channels of the same recording periods	The datalogger channel to be display is selected here. In a display element, only those channels with the same recording periods can be displayed. For a selection to be possible here, at least one datalogger channel must have been added in the "Datalogger" parameter group in advance.
Curve 1 / 2: Name	[Curve]	A name for the curve of the appropriate datalogger channel can be entered here. This name is displayed in the legend of the display element. The legend must then be enabled using the "Display legend" parameter.
Curve 1 / 2: Curve type	Min Average value Max	Telegrams reaching the communication object of a datalogger channel are divided up within a recording period to various time intervals and assigned to them. At the end of each time period, the telegrams received are evaluated and a minimum and maximum interval value determined. In addition, an average value is calculated and saved. The smallest and largest values are evaluated as the minimum and maximum values. To calculate the average, the recorded values are totalled and divided by the number of recorded values. If, within a time period, only one telegram data value was received, then the minimum value = maximum value = average value.

Curve 1 / 2: Amplification	1	<p>This parameter specifies which recorded data value is to be displayed in the diagram as the "curve type" (maximum value, minimum value or average value). When a datalogger channel is displayed with differentials in the data value recording, it is not possible to select the curve type as there can only be one differential value displayed for each interval.</p>
Curve 1 / 2: Offset	0	<p>Reinforcement (multiplier) can be added to the measured values of a channel to allow the option of modification to the desired measured value ranges in the diagram.</p> <p>i In a diagram, the values of a datalogger channel are displayed, without reformatting, in the way that they are received in the data telegram from the bus, providing that no reinforcement or offset is specified in the configuration of the curve. As a result, a data value, for example, received in the format DPT 5,001 (1 byte value) in a value range of 0...255 can be displayed in the diagram. If, in this example, percentage values should be displayed (e.g. command values), the data values can be reformatted by the reinforcement. In such a case, a 1 byte data value (0...255) with a reinforcement of "0.392" can be converted to a percentage data value (0...100 %).</p>
Y axis: Display axis title	Yes No	<p>A static offset can be added to the measured values of a channel to allow the option of modification to the desired measured value ranges in the diagram. An offset not equal to "0" shifts the curve along the Y axis in a positive or negative direction.</p>
Y axis Axis title	[Y axis]	<p>The Y axis of the graphic display can be overwritten with a text. This parameter defines whether the text heading of the Y axis should be displayed in the display element.</p>
		<p>The Y axis title is specified here. This parameter is only visible when the axis title of the Y axis is to be displayed.</p>

Y axis: automatic scaling	Yes No	The Y axis can be scaled automatically according to the values to be displayed (specified by minimum and maximum values of the recording period / "Yes" setting) or, alternatively, can be permanently configured in a value range ("No" setting). If the scaling of the Y axis is fixed, and there is a data value outside the specified minimum or maximum limits, then the data value curve is drawn in vertically upwards or downwards from the two neighbouring data points.
Y axis Min. axis scaling	0	The lower minimum value of the Y axis can be defined at this point. The value may be either positive or negative, but may not exceed the maximum value. During setting, it should be ensured that the expected datalogger values do not undershoot the minimum value. Otherwise the data value curve would be drawn vertically downward from the two neighbouring data points of the undershoot. This parameter is only visible on "Y axis: automatic scaling = No".
Y axis Max. axis scaling	100	The upper maximum value of the Y axis can be defined at this point. The value may be either positive or negative, but may not undershoot the minimum value. During setting, it should be ensured that the expected datalogger values do not exceed the maximum value. Otherwise the data value curve would be drawn vertically upward from the two neighbouring data points of the overshoot. This parameter is only visible on "Y axis: automatic scaling = No".
Y axis Display axis labelling	Yes No	The axis labelling of the Y axis can be shown or hidden. With axis labelling, only the subdivisions and additional lines are shown, but not the numeric values of the scale (minimum and maximum value).
Y axis Axis labelling format	###.#	This parameter can be used to specify the format of the displayed numeric values of the Y axis scale. Pressing "... " can set the format using an editor, using which the predefined standard format can be changed through manual inputs.

		This parameter is only visible on "Y axis: display axis labelling = No".
Y axis Number of subdivisions	1... 10 ...20	The Y axis can be given subdivisions to simplify the legibility of the diagram. This parameter specifies the number of subdivisions.
Y axis Number of additional lines	No additional lines Every subdivision Every other subdivision Subdivision in the centre	The entire diagram can be given additional horizontal lines, orientated to the Y axis, to improve legibility. This parameter specifies the number of additional lines according to the subdivisions.
X axis: Display axis title	Yes No	The X axis of the graphic display can be described with a text. This parameter defines whether the text description of the X axis should be displayed in the display element.
X axis: Axis title	[X axis]	The X axis title is specified here. This parameter is only visible when the axis title of the X axis is to be displayed.
X axis: Number of subdivisions	1... 10 ...60	The X axis can be given subdivisions to simplify the legibility of the diagram. This parameter specifies the number of subdivisions.
X axis: Number of additional lines	No additional lines Every subdivision Every other subdivision Subdivision in the centre	The entire diagram can be given additional vertical lines, orientated to the X axis, to improve legibility. This parameter specifies the number of additional lines according to the subdivisions.
X axis: Display axis labelling	Yes No	The axis labelling of the X axis can be shown or hidden. With axis labelling, only the subdivisions and additional lines are shown, but not the time or date values.
<i>For "Access check" display function...</i>		
Display	Code number Status byte	This parameter defines which part information of the communication objects is to be shown in the display element.

Bit of the status byte to be displayed	Encryption info Read direction Authorisation Error status	A part of the part information of the status byte can be selected here. This parameter is only visible on "Display = Status byte".
Image text for 1	Encrypted L->R Accepted Error	An image text must be defined for the status bit here. Various image texts are predefined, which can be modified, according to the selected part information of the status byte. This parameter is only visible on "Display = Status byte".
Image text for 0	Normal L->R Not accepted OK	An image text must be defined for the status bit here. Various image texts are predefined, which can be modified, according to the selected part information of the status byte. This parameter is only visible on "Display = Status byte".
Value alignment	Left-align Centred Right-align User-defined	This parameter defines the horizontal arrangement of the status display within the display element. In the "User-defined" setting, an additional parameter is displayed for precise positioning.
X position of the value	1	The alignment of the status display within a display element is specified here. The settable value depends on the width of the display element.
<i>For "Restraint" display function...</i>		
Text for Restraint ON	No presetting	An image text can be configured here for active restraint with switching status "ON".
Text for Restraint OFF	No presetting	An image text can be configured here for active restraint with switching state "OFF".
Text for not restrained ON	No presetting	An image text can be configured here for inactive restraint and a received switching state "ON".
	No presetting	

Text for not restrained OFF		An image text can be configured here for inactive restraint and a received switching state "OFF".
Value alignment	Left-align Centred Right-align User-defined	This parameter defines the horizontal arrangement of the status display within the display element. In the "User-defined" setting, an additional parameter is displayed for precise positioning.
X position of the value	1	The alignment of the status display within a display element is specified here. The settable value depends on the width of the display element.
<i>For "Operating mode switch" display function...</i>		
Operating mode switch via	Individual objects (1bit) Connex	The operating mode can be selected using four different 1 bit objects or a shared 1 byte connex object. Different communication objects are displayed according to this setting.
Status display	As text As icon	The operating mode can either be displayed by an image text or a status icon.
Text for Comfort mode	No presetting	An image text can be configured here for active comfort operation. This parameter is only visible with "Status display = as text".
Text for standby operation	No presetting	An image text can be configured here for active standby operation. This parameter is only visible with "Status display = as text".
Text for night reduction	No presetting	An image text can be configured here for active night reduction. This parameter is only visible with "Status display = as text".
Text for frost / heat protection	No presetting	An image text can be configured here for active frost/heat protection. This parameter is only visible with "Status display = as text".

Text for automatic operation	No presetting	An icon can be configured here for active automatic operation. This parameter is only visible with "Status display = as text" and "Operating mode switch via = Connex".
Icon for comfort operation	No presetting	An icon can be configured here for active comfort operation. This parameter is only visible with "Status display = as icon".
Icon for standby operation	No presetting	An icon can be configured here for active standby operation. This parameter is only visible with "Status display = as icon".
Icon for night reduction	No presetting	An icon can be configured here for active night reduction. This parameter is only visible with "Status display = as icon".
Icon for frost / heat protection	No presetting	An icon can be configured here for active frost/heat protection. This parameter is only visible with "Status display = as icon".
Icon for automatic operation	No presetting	An icon can be configured here for active automatic operation. This parameter is only visible with "Status display = as icon" and "Operating mode switch via = Connex".
Value alignment	Left-align Centred Right-align User-defined	This parameter defines the horizontal arrangement of the status display within the display element. In the "User-defined" setting, an additional parameter is displayed for precise positioning.
X position of the value	1	The alignment of the status display within a display element is specified here. The settable value depends on the width of the display element.
<i>For display function "Collective feedback"...</i>		
Channel to be evaluated	1...16	Here, there must be a definition of which channel bit is to be evaluated in the collective feedback. Only the channel defined here is taken into account in the

		status display of the effected display element.
Status display	As text As icon	The switching state can either be displayed by an image text or a status icon.
Image text for 'On' status	[On]	When a channel is switched on, the image text defined here is displayed. This parameter is only visible with "Status display = as text".
Image text for 'Off' status	[Off]	When a channel is switched off, the image text defined here is displayed. This parameter is only visible with "Status display = as text".
Image text for 'Invalid' status	[Invalid]	If the channel specified in the "Channel to be evaluated" parameter is not included in the collective feedback, i.e. the collective feedback of an actuator not actually in the specified channel is evaluated, then the image text defined at this point is displayed. This parameter is only visible with "Status display = as text".
Icon for 'On' status	No presetting	When a channel is switched on, the icon defined here is displayed. This parameter is only visible with "Status display = as icon".
Icon for 'Off' status	No presetting	When a channel is switched off, the icon defined here is displayed. This parameter is only visible with "Status display = as icon".
Icon for 'Invalid' status	No presetting	If the channel specified in the "Channel to be evaluated" parameter is not included in the collective feedback, i.e. the collective feedback of an actuator not actually in the specified channel is evaluated, then the icon defined at this point is displayed. This parameter is only visible with "Status display = as icon".
Value alignment	Left-align Centred Right-align User-defined	This parameter defines the horizontal arrangement of the status display within the display element. In the "User-defined" setting, an additional parameter

is displayed for precise positioning.

X position of the value 1

The alignment of the status display within a display element is specified here. The settable value depends on the width of the display element.

For "Dimmer actuator load type" display function...

Status display **As text**
As icon The load type can either be displayed by an image text or a status icon.

Image text for 0 'Undefined' **[Undefined]**

If the load type of a dimmer actuator is fed back as undefined, then the display element will display the text defined here.
This parameter is only visible with "Status display = as text".

Image text for 1 'Capacitive' **[Capacitive]**

If the load type of a dimmer actuator is fed back as capacitive, then the display element will display the text defined here.
This parameter is only visible with "Status display = as text".

Image text for 2 'Inductive' **[Inductive]**

If the load type of a dimmer actuator is fed back as inductive, then the display element will display the text defined here.
This parameter is only visible with "Status display = as text".

Image text for 3 'Universal / Capacitive' **[Universal / Capacitive]**

If the a dimmer actuator is working according to the universal principle and the load type is fed back as capacitive, then the display element will display the text defined here.
This parameter is only visible with "Status display = as text".

Image text for 4 'Universal / Inductive' **[Universal / Inductive]**

If the a dimmer actuator is working according to the universal principle and the load type is fed back as inductive, then the display element will display the text defined here.
This parameter is only visible with "Status display = as text".

Icon for 0 'Undefined' No presetting

		<p>If the load type of a dimmer actuator is fed back as undefined, then the display element will display the icon defined here. This parameter is only visible with "Status display = as icon".</p>
Icon for 1 'Capacitive'	No presetting	<p>If the load type of a dimmer actuator is fed back as capacitive, then the display element will display the icon defined here. This parameter is only visible with "Status display = as icon".</p>
Icon for 2 'Inductive'	No presetting	<p>If the load type of a dimmer actuator is fed back as inductive, then the display element will display the icon defined here. This parameter is only visible with "Status display = as icon".</p>
Icon for 3 'Universal / Capacitive'	No presetting	<p>If the a dimmer actuator is working according to the universal principle and the load type is fed back as capacitive, then the display element will display the icon defined here. This parameter is only visible with "Status display = as icon".</p>
Icon for 4 'Universal / Inductive'	No presetting	<p>If the a dimmer actuator is working according to the universal principle and the load type is fed back as inductive, then the display element will display the icon defined here. This parameter is only visible with "Status display = as icon".</p>
Value alignment	Left-align Centred Right-align User-defined	<p>This parameter defines the horizontal arrangement of the status display within the display element. In the "User-defined" setting, an additional parameter is displayed for precise positioning.</p>
X position of the value	1	<p>The alignment of the status display within a display element is specified here. The settable value depends on the width of the display element.</p>

☐ Page -> [Display element designation] - [Display element function] -> [Button designation] - [Button function] -> General

Designation **[Button]** A button designation can be entered here, which is only displayed in the tree

structure within the ETS plug-in.

Text for line 1	[Back]	Two lines of text are available to display the button function, which are positioned horizontally in the function button shown on the screen. The first line of the display text is specified here. Function buttons assigned to a display element only appear on the screen if two-click operation was configured.
X position for line 1	0	This parameter specifies the X position of the first line of the button text.
Text for line 2	No presetting	Two lines of text are available to display the button function, which are positioned horizontally in the function button shown on the screen. The second line of the display text is specified here. Function buttons assigned to a display element only appear on the screen if two-click operation was configured.
X position for line 2	0	This parameter specifies the X position of the second line of the button text.

☐ Page -> [Display element designation] - [Display element function] -> [Button designation] - [Button function] -> Function

Function	<p>No function</p> <p>Switching function of the display element</p> <p>Dimming function of the display element</p> <p>Blind function of the display element</p> <p>Value display of the display element</p> <p>Restraint function of the display element</p> <p>Operating mode switch of the display element</p> <p>Switching</p> <p>Blind</p> <p>Dimming</p>	<p>Depending on the function of the display element, an appropriate function button can assume different operating functions. Some of the functions are not available for all the display elements. If the button function refers to the display element directions (setting "... of the display element), the objects of the display element are used. Otherwise separate objects are shown for the button. In this case, the function button works independently.</p>
----------	---	---

	Value	
	Light scene	
	Restraint	
	Open page	
<i>For "Switching function of the display element" button function...</i>		
Function on actuation	No function On Off Toggle	The switching command specified here is executed for as long as the button is held down.
Function on release	No function On Off Toggle	The switching command specified here is executed when a button is released.
<i>For "Dimming function of the display element" button function...</i>		
Dimming, button function	No function Darker (OFF) Brighter (ON) Brighter / darker (TOGGLE)	The dimming command specified here is executed for as long as the button is held down. This parameter is only visible when the display element displays a switching state.
Dimming, button function	Brightness value Edit	Here, it is possible to configure whether a permanently defined brightness value is transmitted to the bus when the button is pressed or whether an editor screen opens on the display, allowing the user to edit a brightness value. This parameter is only visible when the display element displays a brightness value.
Value (%)	0... 50 ...100	Here, the value is configured which is transmitted to the bus when a button is pressed. This parameter is only visible when the dimming button function is set to "Brightness value" and the display type of the brightness value object of the display element is set to "0...100 %".
Value (0...255)	0... 127 ...255	Here, the value is configured which is transmitted to the bus when a button is pressed.

		This parameter is only visible when the dimming button function is set to "Brightness value" and the display type of the brightness value object of the display element is set to "0...255".
Minimum value (%)	0..100	The minimum value by for a value adjustment is configured here. This parameter is only visible when the dimming button function is set to "Edit" and the display type of the brightness value object of the display element is set to "0...100 %".
Maximum value (%)	0...100	The maximum value by for a value adjustment is configured here. This parameter is only visible when the dimming button function is set to "Edit" and the display type of the brightness value object of the display element is set to "0...100 %".
Minimum value (0...255)	0...255	The minimum value by for a value adjustment is configured here. This parameter is only visible when the dimming button function is set to "Edit" and the display type of the brightness value object of the display element is set to "0...255".
Maximum value (0...255)	0...255	The maximum value by for a value adjustment is configured here. This parameter is only visible when the dimming button function is set to "Edit" and the display type of the brightness value object of the display element is set to "0...255".
<i>For "Blind function of the display element" button function...</i>		
Blind function	Up Down Toggle	The blind command specified here is executed for as long as the button is held down.
<i>For "Value display of the display element" button function...</i>		
Value function	Transmit Edit	Here, it is possible to configure whether a permanently defined value is transmitted to the bus when the button is pressed or whether an editor screen

opens on the display, allowing the user to edit a value.

Value to be transmitted **0**

Here, the value is configured which is transmitted to the bus when a button is pressed.
The settable value range depends on the configured value display of the display element.

Minimum value -671088.64

The minimum value by for a value adjustment is configured here.
The settable value range and also the presetting depend on the configured value display of the display element.
This parameter is only visible if the value function is set to "Edit".

Maximum value 670760.96

The maximum value by for a value adjustment is configured here.
The settable value range and also the presetting depend on the configured value display of the display element.
This parameter is only visible if the value function is set to "Edit".

For "Restraint function of the display element" button function...

Button function

No function
On
Off
Toggle
Restrained ON
Restrained OFF
Restraint off

Here, it is possible to configure which restraint command is transmitted to the bus when a button is pressed.

For "Operating mode switch of the display element" button function...

Button function

No function
Comfort
Standby
Night reduction
Frost/ heat protection
Automatic operation

Pressing the button activates a defined operating mode. The switch is made using the object(s) of the display element. Automatic mode is only available when the operating mode is selected using an object according to the Connex standard.

For "Switching" button function...

Function on actuation	No function On Off Toggle	The switching command specified here is executed for as long as the button is held down.
Function on release	No function On Off Toggle	The switching command specified here is executed when a button is released.
<i>For "Dimming" button function...</i>		
Dimming, button function	No function Darker (OFF) Brighter (ON) Brighter / darker (TOGGLE)	The dimming command specified here is executed for as long as the button is held down.
Time base between switching and dimming	10 ms 100 ms 1 s	This parameter specifies the time base for the time from which the panel detects long actuation to transmit a dimming telegram. For improved accuracy, we recommend selecting a small time base with a large time factor.
Time factor between switching and dimming	0... 6 ...127	This parameter specifies the time factor for the time from which the panel detects long actuation to transmit a dimming telegram. For improved accuracy, we recommend selecting a small time base with a large time factor.
<i>For "Blind" button function...</i>		
Blind function	Up Down Toggle	The blind command specified here is executed for as long as the button is held down.
Time base between short/long-time operation	10 ms 100 ms 1 s	This parameter specifies the time base for the time from which the panel detects long actuation. For improved accuracy, we recommend selecting a small time base with a large time factor.
Time factor between short/long-time operation	0... 3 ...127	This parameter specifies the time factor for the time from which the panel detects long actuation. For improved accuracy, we recommend selecting a small time base with a large time factor.

Slat adjust time, basic

	10 ms 100 ms 1 s	This parameter specifies the time base for the time required for complete rotation of the slats. For improved accuracy, we recommend selecting a small time base with a large time factor.
Slat adjust time, factor	0... 6 ...127	This parameter specifies the time factor for the time required for complete rotation of the slats. For improved accuracy, we recommend selecting a small time base with a large time factor.

For "Value" button function...

Value display	DPT 9.001 ... 9.021 (2 byte value) DPT 5.001 ... 5.004 (1 byte relative value) DPT 14.000 ... 14.079 (4 byte – IEEE float) DPT 8.001 (2 byte – counter with plus/minus sign) DPT 7.001(2 byte – counter) DPT 13.001 (4 byte counter with plus/minus sign) DPT 12.001 (4 byte counter) DPT 6.010 (1 byte counter with plus/minus sign) DPT 5.010 (1 byte counter)	Defines the value range and the data format of the corresponding communication object.
---------------	---	--

Value to be transmitted	0	Here, the value is configured which is transmitted to the bus when a button is pressed. The settable value range depends on the configured value display.
-------------------------	----------	--

For "Light scene" button function...

Light scene	--- ... List of the defined light scenes	When actuated, the panel opens one of the saved light scenes. Before entering the required light scene, it must be created in the tree structure.
-------------	--	---

For "Restraint" button function...

Button function	No function On Off Toggle Restrained ON Restrained OFF Restraint off	Here, it is possible to configure which restraint command is transmitted to the bus when a button is pressed.
-----------------	---	---

For "Open page" button function...

Button function	Return List of projected user pages Timer switch - Page 1 of 2 Timer switch - Page 1 of 2 Service page Light scenes - Page 1 of 3 Light scenes - Page 2 of 3 Light scenes - Page 3 of 3 Signalling system Presence simulation Message list Overview of RSS feeds Mailboxes	The basic setting for opening pages is always a return to the page, from which the current page was opened. However, other user pages or system pages can be opened when a button is pressed. In order to select a user page, this must first have been created in the tree structure ("Pages" parameter node).
-----------------	--	---

☐ Service page -> Area 1

Heading	[Display setting]	Predefined page heading of the first service area, which can be changed as necessary.
---------	--------------------------	---

Password level	No password protection Password level 1 Password level 2 Password level 3 Password level 4	If a password level is set here, then the user must enter the correct password to open the page, if the previous page has a lower password level.
----------------	---	---

☐ Service page -> Area 2

Heading	[System setting]	Predefined page heading of the second service area, which can be changed as necessary.
---------	-------------------------	--

Password level	No password protection Password level 1 Password level 2 Password level 3 Password level 4	If a password level is set here, then the user must enter the correct password to open the page, if the previous page has a lower password level.
----------------	---	---

Approve colour scheme selection	No Yes	If "Yes" is set here, then the user can select a new "System colour scheme" on the panel at a later time.
---------------------------------	------------------	---

Service address, line 1	No presetting	The service page in area 2 can display any service address which can be made up of up to 5 lines. This parameter defines the display text in the first line of the service address.
Service address, line 2	No presetting	The service page in area 2 can display any service address which can be made up of up to 5 lines. This parameter defines the display text in the second line of the service address.
Service address, line 3	No presetting	The service page in area 2 can display any service address which can be made up of up to 5 lines. This parameter defines the display text in the third line of the service address.
Service address, line 4	No presetting	The service page in area 2 can display any service address which can be made up of up to 5 lines. This parameter defines the display text in the fourth line of the service address.
Service address, line 5	No presetting	The service page in area 2 can display any service address which can be made up of up to 5 lines. This parameter defines the display text in the fifth line of the service address.
<input type="checkbox"/> Service page -> Area 3		
Heading	[Administrator]	Predefined page heading of the third service area, which can be changed as necessary.
Password level	No password protection Password level 1 Password level 2 Password level 3 Password level 4	If a password level is set here, then the user must enter the correct password to open the page, if the previous page has a lower password level.
<input type="checkbox"/> Status line -> [Status element designation] - [Status element function] -> General		
Designation	[Status element]	Predefined designation of the status element which appears only in the node name of the plug-in and which can be modified as necessary.

☐-| Status line -> [Status element designation] - [Status element function] -> Function

Function	Event display Collective fault message Value Date Time, ASCII text	The function of the status element can be selected here. The individual functions mostly correspond to the display element functions of the same name. The event display corresponds to a display element with the function "Switching". The collective fault message is active when at least one error fault message has been activated. Different communication objects are displayed according to this selection.
----------	---	---

For "Event display" function...

Display	As text As icon	The switching state can be displayed in the status line, either as text or, alternatively, as an icon. This parameter is only visible on "Function = Event display".
---------	---------------------------	---

Event display image text on Bit = 1	[On]	Here, the text can be entered to be displayed in the status line on status "1" (switched on). This parameter is only visible with "Display = as text".
-------------------------------------	-------------	---

Event display image text on Bit = 0	[Off]	Here, the text can be entered to be displayed in the status line on status "0" (switched off). This parameter is only visible with "Display = as text".
-------------------------------------	--------------	--

Event display icon on Bit = 1	No presetting	Here, an icon can be configured using the image list to be displayed in the status line on status "1" (switched on). This parameter is only visible with "Status display = as icon".
-------------------------------	---------------	---

Event display icon on Bit = 0	No presetting	Here, an icon can be configured using the image list to be displayed in the status line on status "0" (switched off). This parameter is only visible with "Status display = as icon".
-------------------------------	---------------	--

For "Collective fault message" function...

No presetting	The icon images for the display can be
---------------	--

Icon for collective fault message

selected from the image list here.
This parameter is only visible on "Function = Collective fault message".

For "Value" function...

Value display

DPT 9.001 ... 9.021 (2 byte value)

DPT 5.001 ... 5.004 (1 byte relative value)

DPT 14.000 ... 14.079 (4 byte – IEEE float)

DPT 8.001 (2 byte – counter with plus/minus sign)

DPT 7.001 (2 byte – counter)

DPT 13.001 (4 byte – counter with plus/minus sign)

DPT 12.001 (4 byte – counter)

DPT 6.010 (1 byte – counter with plus/minus sign)

DPT 5.010 (1 byte - counter)

This parameter defines the value range and the data format of the corresponding communication object. Additional parameters are displayed depending on this setting. This parameter is only visible on "Function = Value".

Display format

0 ... 255

0 ... 100%

0...360°

User-defined

The display format of the value is defined here. This parameter is only visible with "Value display = DPT 5.001 ... 5.004(1 byte)".

Offset

0

This parameter can be used to adapt the value of the communication object to the required format using a static offset (positive or negative).

Amplification

1

This parameter can be used to adapt the value of the communication object to the required format using reinforcement (multiplier).

Format

#####.#

This parameter can be used to specify the format of the displayed value. Pressing "..." can set the format using an editor, using which the predefined standard format can be changed through manual inputs.

Unit

%

List of predefined units

This parameter can be used to specify a unit for the format DPT 5.001 ... 5.004. The unit is displayed immediately behind

the display value.

For "Date" function...

Source	Internal EIB	The displayed date is derived either from the internal real time clock of the panel or from an additional communication object, i.e. from the KNX/EIB.
--------	------------------------	--

For "Time" function...

Source	Internal EIB	The displayed time is derived either from the internal real time clock of the panel or from an additional communication object, i.e. from the KNX/EIB.
--------	------------------------	--

Offset [hours]	-12... 0 ...12	To adjust the time to various timezones, the time can be corrected by a static hour offset here.
----------------	-----------------------	--

For "ASCII text" function...

Length of the ASCII text	1... 14	This setting allows shortening of the received texts for the display.
--------------------------	----------------	---

X position of the value	0	The alignment of the status text or icon within a status line is specified here. In the text display, the value should be set in such a way that multiple status elements in th status line do not overlap (different X position values). However, overlapping is always possible, e.g. in the display of different icons. This parameter presetting depends on the selected function of the status element.
-------------------------	---	--

Timer switch -> General

Password level	No password protection Password level 1 Password level 2 Password level 3 Password level 4	If a password level is set here, then the user must enter the correct password to open the page, if the previous page has a lower password level.
----------------	---	---

Timer switch -> Location data

Geographic longitude of the location	0 7.62° ... Selection of the geographic position using the co-ordinates editor	For the astro function of the timer switch to work correctly, the geographic position must be set. This parameter, together with the co-ordinate editor, defines the geographic position
--------------------------------------	---	--

(longitude) of the installation location of the panel.

Geographic latitude of the location **N 51.22°**
 ...
 Selection of the geographic position using the co-ordinates editor

For the astro function of the timer switch to work correctly, the geographic position must be set. This parameter, together with the co-ordinate editor, defines the geographic position (latitude) of the installation location of the panel.

☐ Timer switch -> Timer switch Page x of 2 (x = 1, 2) -> General

Heading **[Timer switch - Page 1 of 2]**

Predefined designation, displayed only in the parameter node name of the timer switch page and which can be modified as necessary. This parameter is available on each timer switch page (1, 2).

☐ Timer switch -> Timer switch Page x of 2 (x = 1, 2) -> [Channel designation] - [Channel function] -> General

Designation **[Channel]**

A designation of the timer switch channel can be entered here, which is only displayed in the tree structure within the ETS plug-in.

Text **[Channel]**

The display text of the timer switch channel is specified here. The text appears within the display element on the screen.

X position of the text **10**

The alignment of the display text within a display element of the timer switch channel is specified here.

☐ Timer switch -> Timer switch Page x of 2 (x = 1, 2) -> [Channel designation] - [Channel function] -> Random function

Max. time offset +/- [in mins., 0 = Off] **0...30**

The switching times of a channel can be triggered offset in a set random period. Each day at 0:00, the panel calculates a time offset individually and randomly for each switching time, by which a switching time is brought forward minute-by-minute (-) or is set back (+). The maximum time offset between the set switching time and the actual time of the version can be configured using this parameter. This allows time offsets of between 1 and 30 minutes. The setting "0" for the time offset completely deactivates the random function for the timer switch channel. The panel

randomly determines a time from the configured maximum time offset and adds this time either to the set switching time or, alternatively, subtracts it from the switching time.

☐ Timer switch -> Timer switch Page x of 2 (x = 1, 2) -> [Channel designation] - [Channel function] -> Astro function

Channel affects

Shadow
Lighting

The astro function allows the control of a lighting or shading system depending on sunrise and sunset and a limit time (switching time).
An astro function usually affects lighting (e.g. exterior lighting) or shading (e.g. roller shutters). The behaviour of the panel when processing the astro switching times varies according to these applications. This parameter defines the astro behaviour irrespective of the set data format of the channel.

☐ Timer switch -> Timer switch Page x of 2 (x = 1, 2) -> [Channel designation] - [Channel function] -> Switching times

Switching time x (x = 1...8)

00:00 - - - - -
Definition of the switching time using the switching time editor

The ETS plug-in offers the opportunity to predefine the switching times or a timer switch channel.

i For the switching times preset for the plug-in to be correctly transferred to the panel during the programming operation, the parameter "Overwrite all switching times of the timer switch" in the top parameter node of the plug-in is set to "Yes". Before first commissioning of the panel, set this parameter to "Yes", if a switching time specification is configured in the plug-in. Otherwise, the switching times preset in the plug-in are not transferred to the panel. If the parameter is configured to "Yes", the switching times changed directly on the panel are always overwritten during programming operations.

☐ Timer switch -> Timer switch Page x of 2 (x = 1, 2) -> [Channel designation] - [Channel function] -> Function

Function

Switching
Value
Light scene
Operating mode switch

The ETS plug-in offers the opportunity to predefine the switching times or a timer switch channel.

i The function of the time switch channel and thus its object data format can be set here. The settings and functions mostly correspond to the display element functions of the same name (see parameter description of the display elements). Different communication objects are visible according to this selection.

☐ Timer switch -> Timer switch Page x of 2 (x = 1, 2) -> [Channel designation] - [Channel function] -> [Button designation] - [Button function] -> General

Designation **[Button]** A button designation can be entered here, which is only displayed in the tree structure within the ETS plug-in.

Text for line 1 **[Change]** Two lines of text are available to display the button function of a timer switch channel, which are positioned horizontally in the function button shown on the screen. The first line of the display text is specified here.

X position for line 1 **0** This parameter specifies the X position of the first line of the button text.

Text for line 2 No presetting Two lines of text are available to display the button function of a timer switch channel, which are positioned horizontally in the function button shown on the screen. The second line of the display text is specified here.

X position for line 2 **0** This parameter specifies the X position of the second line of the button text.

☐ Timer switch -> Timer switch Page x of 2 (x = 1, 2) -> [Channel designation] - [Channel function] -> [Button designation] - [Button function] -> Function

Function	No function	Depending on the function of the timer switch channel, a channel button can assume different operating functions. If the button function directly refers to the timer switch channel, the objects of the channel are used.
	Switching function of the display element	A predefined screen page opens to change the timer switch settings for the channel. The page opening is preset as a return. A page must also be created here in the tree structure before it can be opened.
	Value display of the display element	This parameter presetting depends on
	Light scene of the display element	
	Operating mode switch of the display element	

Change timer switch setting for channel	the channel button number. The additionally visible parameters, which are dependent on the selection, correspond to the functions of the normal function buttons (see parameter description of the function buttons).
Open page	

☐ Fault messages -> [Fault message designation] -> General

Designation	[Fault message]	Predefined designation, which only appears in the parameter node name and which can be modified as necessary.
Activation by object value	0 telegram 1 telegram	This parameter defines upon which object value the fault message is activated. The inverted object value exits the fault message.
Text of fault message	No presetting	A text can be entered here, which is displayed both in the message window and, if required, is logged in the message list.
Acoustic signal	Yes No	The piezo buzzer can be enabled here to signal the fault message acoustically.
In case of fault message, blockage of additional fault message windows	No presetting	This parameter opens a separate dialog, in which it is possible to specify which of the other fault messages are blocked when this signal is activated.

☐ Fault messages -> [Fault message designation] -> Message window

Open message window	Yes No	It is possible to specify here whether a message window is also displayed on the panel when a fault occurs. If the message window is displayed, the signal can be acknowledged there.
Record sender address	Yes No	The physical addresses of the devices, which have activated or deactivated a fault message, can be recorded in the message list. This parameter is only visible on "Open message window = Yes".
Text, line 2	No presetting	The second line of the display text of the fault message in the message window can be specified here. This parameter is only visible on "Open

message window = Yes".

Text, line 3	No presetting	The third line of the display text of the fault message in the message window can be specified here. This parameter is only visible on "Open message window = Yes".
Display external text on fault message	Yes No	If this parameter is set to "Yes", then an additional 14 byte object becomes visible, which can receive a text message. This text is then also displayed in the message window. To receive this external text, the display of the message window is delayed internally. This parameter is only visible on "Open message window = Yes".
☐ Fault messages -> [Fault message designation] -> Acknowledgement		
Acknowledgment via button	Only internal effect Transmits object value 0 Transmits object value 1 Disabled	This parameter defines whether an acknowledgement in the message window has a purely internal effect or whether the acknowledgement is also transmitted to the bus via an acknowledgement object. The latter is advisable if, for example, a fault is signalled on multiple bus subscribers and acknowledgement is also required there. The settings "Transmits object value 0" and "Transmits object value 1" specifies the telegram polarity for the acknowledgement telegram of the panel. The "Disabled" setting deactivates acknowledgement via the message window. This parameter is only visible on "Open message window = Yes".
External acknowledgment through object value	1 telegram 0 telegram Disabled	Irrespective of the acknowledgement via the message window, it is also possible to reset a fault message using an external acknowledgement object. This parameter enables the external acknowledgement object and sets the telegram polarity. The "Blocked" setting only allows acknowledgement via the message window, if it is shown.
Representation after acknowledgement	Yes No	Acknowledgement does not mean that the fault has automatically been eliminated. As a reminder, the fault message window can be displayed

again automatically after a defined period, if the cause of the fault has not been eliminated, i.e. the fault message is still active.

Representation after	1 min 5 min 10 min 30 min 1 hr 2 hr	This parameter defines the time after which an acknowledged but not eliminated fault is represented. This parameter is only visible on "Representation after acknowledgement = Yes".
----------------------	---	--

Open page	--- ... List of projected pages	After acknowledgement, the page projected here can be opened automatically. It can only be opened when there is no additional fault message. This parameter is only visible on "Open message window = Yes".
-----------	---------------------------------------	---

Fault messages -> [Fault message designation] -> Message list

Entry in message list	Yes No	If this parameter is set to "Yes", then a fault message is logged in the panel's message list.
-----------------------	------------------	--

Enter 'Incoming'	Yes No	If this parameter is set to "Yes", then an incoming fault message (fault message activated) is logged in the panel's message list together with the time. This parameter is only visible on "Entry in message list = Yes".
------------------	------------------	--

Enter 'Departing'	Yes No	If this parameter is set to "Yes", then a departing fault message (fault message deactivated) is logged in the panel's message list together with the time. This parameter is only visible on "Entry in message list = Yes".
-------------------	------------------	--

Enter 'Acknowledged'	Yes No	If this parameter is set to "Yes", then the acknowledgement of a fault message is logged in the panel's message list together with the time. This parameter is only visible on "Entry in message list = Yes".
----------------------	------------------	---

Timers -> [Timer designation]

Designation	[Filtering/Time]	Predefined designation, which only appears in the parameter node name and which can be modified as necessary.
-------------	-------------------------	---

Input -> Output	<p>On - > --- / Off -> ---</p> <p>On -> On / Off -> ---</p> <p>On - > --- / Off -> Off</p> <p>On -> On / Off -> Off</p> <p>On - / Off -> Off -> ---</p> <p>On -> --- Off -> On</p> <p>On -> Off / Off -> On</p> <p>On - > Toggle / Off -> ---</p> <p>On - > --- / Off -> Toggle</p> <p>On - > Toggle / Off -> Toggle</p>	<p>The timer can output a value settable here, depending on the value of the input object (filter function).</p>
Time function, output	<p>No delay</p> <p>Switch-on delay</p> <p>Switch-off delay</p> <p>ON delay and OFF delay</p>	<p>The input telegram can be forwarded to the output of the filtering/timer after a delay (time delay function). It is possible to specify here whether the time delay is active and, if so, which switching state (ON and / or OFF) should be delayed. With "ON delay and OFF delay", the delay times can be set individually.</p>
Switch-on delay basis	<p>100 ms</p> <p>1 s</p> <p>1 min</p>	<p>This parameter defines the time base for the switch-on delay.</p> <p>This parameter is only visible on "Time function, output = On delay" or "Time function, output = ON delay and OFF delay".</p>
Switch-on delay factor	<p>0...1...255</p>	<p>This parameter defines the time factor for the switch-on delay.</p> <p>This parameter is only visible on "Time function, output = On delay" or "Time function, output = ON delay and OFF delay".</p>
Switch-off delay basis	<p>100 ms</p> <p>1 s</p> <p>1 min</p>	<p>This parameter defines the time base for the switch-off delay.</p> <p>This parameter is only visible on "Time function, output = Off delay" or "Time function, output = ON delay and OFF delay".</p>
Switch-off delay factor	<p>0...1...255</p>	<p>This parameter defines the time factor for the switch-off delay.</p>

		This parameter is only visible on "Time function, output = Off delay" or "Time function, output = ON delay and OFF delay".
Blocking object available	Yes No	The filtering/timer can also be fitted with a blocking object. If the blocking object is used, the timer ignores changes to the input when the block is active.
Behaviour of blocking object	1 = enabled; / 0 = disabled 0 = enabled / 1 = disabled	The telegram polarity of the blocking object can be set here. This parameter is only visible on "Blocking object available = Yes".
Transmit after block enable	Yes No	After the block, the current input value can immediately be processed further ("Yes" setting), or the timer waits for the next input telegram ("No" setting). This parameter is only visible on "Blocking object available = Yes".

☐ Logic -> Links -> [Logic gate designation] - [Type of the logic gate link]

Designation	[Logic gate]	Predefined designation, which only appears in the parameter node name and which can be modified as necessary.
Type of logic operation	AND link OR link Exclusive OR link AND with feedback	This parameter defines the logical link function. With an "AND with return", the value of the output is fed back internally to input 1. The result of this is that the output can only have the value "1" when all the other inputs are set to "1" and input 1 receives the value "1" as the last input..
Blocking object available	Yes No	The logic gate can optionally be fitted with a blocking object. If the blocking object is used, the gate ignores changes to the inputs when the block is active.
Behaviour of blocking object	1 = enabled / 0 = disabled 0 = enabled / 1 = disabled	The telegram polarity of the blocking object can be set here. This parameter is only visible on "Blocking object available = Yes".
Transmit after block enable	Yes No	After the block, the current input values can immediately be processed further ("Yes" setting), or the logic gate waits for

the next input telegrams ("No" setting).
This parameter is only visible on
"Blocking object available = Yes".

Transmit on	Each input event Change the output	In the "Transmit on each input event" setting, a new output telegram is sent when the value of the output has not changed on updating or a change to an input. When multiple logic gates are used, this can lead to a higher bus load. In the "Transmit on output change" setting, the bus load is minimised by only transmitting the output telegram when the switching state has also changed.
Filter	No Only transmit "1" telegrams Only transmit "0" telegrams	A filter function can be optionally activated for the output at this point. The filter function set here specifies which output telegrams are transmitted to the bus and are thus forwarded.
□ Logic -> Links -> [Logic gate designation] - [Type of the logic gate link] -> [Input designation]		
Designation	[Input]	Predefined designation, which only appears in the parameter node name and which can be modified as necessary.
Behaviour input	Normal Inverted	It is possible to specify here whether the appropriate gate input is evaluated normally, i.e. not inverted, or inverted.
□ Logic -> Links -> [Logic gate designation] - [Type of the logic gate link] -> [Output designation]		
Designation	[Output]	Predefined designation, which only appears in the parameter node name and which can be modified as necessary.
Behaviour output	Normal Inverted	It is possible to specify here whether the gate output is evaluated normally, i.e. not inverted, or inverted.
□ Logic -> Multiplexer -> [Multiplexer designation] - [Multiplexer function]		
Designation	[Multiplexer]	Predefined designation, which only appears in the parameter node name and which can be modified as necessary.

Blocking object available	Yes No	The multiplexer can optionally be fitted with a blocking object. During a block, no values are forwarded from the input to the outputs.
Behaviour of blocking object	1 = enabled / 0 = disabled 0 = enabled / 1 = disabled	The telegram polarity of the blocking object can be set here. This parameter is only visible on "Blocking object available = Yes".
Transmit after block enable	Yes No	After the block, the current input value can immediately be processed further ("Yes" setting), or the multiplexer waits for the next input telegrams ("No" setting). This parameter is only visible on "Blocking object available = Yes".
Function	1 to 2 multiplexers 1 to 4 multiplexers	With a 1 to 2 multiplexer, there is one control object, as well as one input and two outputs for each channel. With a 1 to 4 multiplexer, there are two control object, and one input and four outputs for each channel.

☐ Logic -> Multiplexer -> [Multiplexer designation] - [Multiplexer function] -> Multiplexer channel - [Object type, multiplexer channel]

Object type, inputs/ outputs	DPT 1.001 (1 bit switching)	The input and the outputs of a multiplexer channel always have the same object type, which can be configured here. Different channels of a multiplexer may user different object types.
	DPT 3.007 (4 bit – dimming)	
	DPT 9.001 ... 9.021 (2 byte – value)	
	DPT 5.001 ... 5.004 (1 byte relative value)	
	DPT 14.000 ... 14.079 (4 byte – IEEE float)	
	DPT 7.001, 8.001 (2 byte – counter)	
	DPT 12.001, 13.001 (4 byte – counter)	
	DPT 16.001, 16.002 (1 byte)	
	DPT 5.010 (1 byte counter)	

☐ Datalogger -> [Datalogger channel designation]

Designation **[Datalogger channel]**

		Predefined designation, which only appears in the parameter node name and which can be modified as necessary.
Data type	<p>DPT 9.001 ... 9.021 (2 byte – value)</p> <p>DPT 5.001 ... 5.004 (1 byte – relative value)</p> <p>DPT 14.000 ... 14.079 (4 byte – IEEE float)</p> <p>DPT 7.001 (2 byte – counter)</p> <p>DPT 8.001 (2 byte – counter with plus/minus sign)</p> <p>DPT 12.001 (4 byte – counter)</p> <p>DPT 13.001 (4 byte – counter with plus/minus sign)</p> <p>DPT 5.010 (1 byte – counter)</p> <p>DPT 6.010 (1 byte – counter with plus/minus sign)</p>	The datatype of the datalogger channel can be set here.
Recording period	<p>Hour (60 intervals of 1 minute)</p> <p>Day (24 intervals of 1 minute)</p> <p>Week (7 intervals of 1 day)</p> <p>Month (31 intervals of 1 day)</p> <p>Year 1 (12 intervals of 1 month)</p> <p>Year 2 (52 intervals of 1 week)</p>	Telegrams reaching the communication object of the datalogger channel are divided up within the recording period configured here to various time intervals and assigned to them. At the end of each time period, the telegrams received are evaluated and a minimum and maximum interval value determined. In addition, an average value is calculated and saved.
Difference formation	<p>Yes</p> <p>No</p>	If the data source is a counter (e.g. electricity meter, people counter, etc.), data recording can be switched to differential calculation here. In so doing, a differential between the last received value and the last value of the previous period is calculated and stored as a

<p>Start value for difference formation</p>	<p>0</p>	<p>display data value in the panel. No calculation of minimum, maximum or average values take place. The calculated data value differentials then, in the case of an electricity meter, directly represent the consumed units of power within a recording period (e.g. month or year).</p>
<p>Poll object cyclically</p>	<p>Yes No</p>	<p>After a device reset (power failure, programming operation), the differential calculation starts at a specified starting value. This is required to initialise the differential formation, so that a differential value can be calculated in the first recording period after a reset. This means that, in addition, there can be an adjustment to defined basic counter levels - for example after the installation of a new electricity meter. The system project planner must enter the starting value here. A distinction must be made between two different cases: If a value is entered in the parameter box (standard value = "0"), the value then evaluates the last data value of the first time period after the reset directly and then shows the difference to the starting value in the display diagram. Alternatively, the parameter field of the start value can be left empty here. In this case, the panel automatically evaluates the first data value received as the start value. This parameter is only visible on "Differential formation = Yes".</p>
<p>Poll interval</p>	<p>*</p>	<p>With activated cyclic polling, the panel transmits a value read telegram (ValueRead) to the bus regularly, after a period of time has elapsed. The data source must then return a value response telegram (ValueResponse) to the panel. The "Read" flag must be set on the transmitting object of the data source for this to function correctly.</p> <p>The polling interval of the cyclic object poll can be set here. This parameter is only visible on "Poll object cyclically = Yes".</p>

i *: The setting options automatically align themselves to the configured recording period and the resulting time periods. This ensures that at least one data value is requested within a time period.

Send e-mail	Yes No	If the panel is connected to a network via an Ethernet connection and an e-mail mailbox is configured to send e-mail messages, the data values recorded by a datalogger channel can be send cyclically by e-mail. In this case, the panel prepares the data in a CSV file and sends it to a specified recipient in a standard e-mail.
e-mail address of the recipient (max. 58 characters)	No presetting	The e-mail address of the recipient of the automatically generated datalogger e-mail message must be configured here. The input format of the address is specified as "local@domain" (example: "xxx@yyy.d-e"). The address may be a maximum of 58 characters in length. This parameter is only visible on "Send e-mail = Yes".
<input type="checkbox"/> Presence simulation -> [Recording object designation]		
Designation	[Recording object]	Predefined designation, which only appears in the parameter node name and which can be modified as necessary.
Data type	DPT 1.001 (1 bit switching) DPT 5.001 ... 5.004 (1 byte relative value)	The data type of a recording object of the presence simulation can be set here.
<input type="checkbox"/> e-mail		
Password level for main e-mail page	No password protection Password level 1 Password level 2 Password level 3 Password level 4	If a password level is set here, then the user must enter the correct password to open the main e-mail page, if the previous page has a lower password level.
Password level for mailbox 1	No password protection Password level 1 Password level 2 Password level 3 Password level 4	If a password level is set here, then the user must enter the correct password to open the first mailbox, if the previous page has a lower password level.

<p>Password level for mailbox 2</p>	<p>No password protection Password level 1 Password level 2 Password level 3 Password level 4</p>	<p>If a password level is set here, then the user must enter the correct password to open the second mailbox, if the previous page has a lower password level.</p>
<p>Password level for mailbox 3</p>	<p>No password protection Password level 1 Password level 2 Password level 3 Password level 4</p>	<p>If a password level is set here, then the user must enter the correct password to open the third mailbox, if the previous page has a lower password level.</p>
<p>Password level for mailbox 4</p>	<p>No password protection Password level 1 Password level 2 Password level 3 Password level 4</p>	<p>If a password level is set here, then the user must enter the correct password to open the fourth mailbox, if the previous page has a lower password level.</p>
<p>Password level for mailbox 5</p>	<p>No password protection Password level 1 Password level 2 Password level 3 Password level 4</p>	<p>If a password level is set here, then the user must enter the correct password to open the fifth mailbox, if the previous page has a lower password level.</p>
<p><input type="checkbox"/> e-mail -> event e-mail -> [event e-mail designation]</p>		
<p>Designation</p>	<p>[e-mail]</p>	<p>Predefined designation, which only appears in the parameter node name and which can be modified as necessary.</p>
<p>Send e-mail on</p>	<p>0 telegram 1 telegram</p>	<p>The e-mail event is transmitted as soon as the panel receives a trigger telegram. The telegram polarity of the trigger telegram can be set here.</p>
<p>Subject (max. 20 characters)</p>	<p><Subject></p>	<p>The subject of the e-mail header can be specified here. It can be a maximum of 20 characters long.</p>
<p>Contents (max. 60 characters)</p>	<p><Contents></p>	<p>The contents of the e-mail message can be specified here. It can be a maximum of 60 characters long.</p>
<p>Recipient 1 (max. 58 characters)</p>	<p>No presetting</p>	<p>Each event e-mail can be sent to up to five different recipients. The e-mail address of the first recipient must be configured here. The input format of the</p>

		address is specified as "local@domain" (example: "xxx@yyy.d-e"). The address may be a maximum of 58 characters in length. At least one recipient address must be entered for each event e-mail.
Recipient 2 (max. 58 characters)	No presetting	Each event e-mail can be sent to up to five different recipients. The e-mail address of the second recipient must be configured here. The input format of the address is specified as "local@domain" (example: "xxx@yyy.d-e"). The address may be a maximum of 58 characters in length. At least one recipient address must be entered for each event e-mail.
Recipient 3 (max. 58 characters)	No presetting	Each event e-mail can be sent to up to five different recipients. The e-mail address of the third recipient must be configured here. The input format of the address is specified as "local@domain" (example: "xxx@yyy.d-e"). The address may be a maximum of 58 characters in length. At least one recipient address must be entered for each event e-mail.
Recipient 4 (max. 58 characters)	No presetting	Each event e-mail can be sent to up to five different recipients. The e-mail address of the fourth recipient must be configured here. The input format of the address is specified as "local@domain" (example: "xxx@yyy.d-e"). The address may be a maximum of 58 characters in length. At least one recipient address must be entered for each event e-mail.
Recipient 5 (max. 58 characters)	No presetting	Each event e-mail can be sent to up to five different recipients. The e-mail address of the fifth recipient must be configured here. The input format of the address is specified as "local@domain" (example: "xxx@yyy.d-e"). The address may be a maximum of 58 characters in length. At least one recipient address must be entered for each event e-mail.
<input type="checkbox"/> Signalling system -> General		
Arming acknowledgement time [s]	2... 3 ...255	This parameter specifies the acknowledgement time for system arming. Acknowledgement takes place

		<p>using the "Arming acknowledgement" object and, in the case of external arming, additionally using the visual alarm (depending on the parameter "Optical acknowledgement for external arming").</p> <p>It is possible to cancel arming acknowledgement by unarming before the arming acknowledgement time has elapsed.</p>
Unarming acknowledgement time [s]	2... 3 ...255	<p>This parameter specifies the acknowledgement time for system unarming. Acknowledgement takes place using the "Unarming acknowledgement" object.</p> <p>It is possible to cancel arming acknowledgement by unarming before the arming acknowledgement time has elapsed.</p>
Switching time, internal siren [s]	2... 90 ...255	<p>If a detector within an armed area responds, or a sabotage detector triggers when armed or any detector is found to be missing, the signalling system switches to the "Alarm" status and activates the internal siren. The internal siren is an alarm encoder activated for a set period of time. The system project planner must set the switching length of the internal siren here.</p> <p>The signalling system automatically deactivates the internal siren when the switching time after the alarm is triggered has elapsed.</p>
Detector poll interval [s]	10 ...255	<p>The signalling system checks that the detectors created in the security areas exist, i.e. that they are still connected to the KNX/EIB and are functioning. The "Detector poll interval", which can be set in this parameter, defines the time between two read telegrams of the panel, i.e. the time between two detector tests. The signalling system polls all the created detector inputs in turn in this way.</p> <p>Example: poll interval: 10 s, 40 detectors have been created. -> A detector is polled every 10 s. After approx. 400 s, all the detectors have been tested. After this, the cycle test is continued again with the first detector.</p> <p>The signalling system tests detectors considered missing cyclically at brief intervals, in order to be able to detect quickly whether or not the detector has reconnected.</p>

Internal arming via the signal page	Yes No	The system can be internally armed or unarmed using the a display element on the "Signalling system" screen page. This parameter can be used to hide the display element for internal arming ("No" setting), so that the system can only be internally armed or unarmed using the appropriate communication object.
External arming via the signal page	Yes No	The system can be externally armed or unarmed using the a display element on the "Signalling system" screen page. This parameter can be used to hide the display element for external arming ("No" setting), so that the system can only be externally armed or unarmed using the appropriate communication object.
<input type="checkbox"/> Signalling system -> Internal arming		
Arming delay, internal [s]	0...255	The arming delay time, which can be set here, specifies after what time after a arming command ("1" telegram via the "Internally armed" object or pressing of the "Arm" button on the panel) the system is actually internally armed. In so doing the signalling system only checks the arming readiness of the security areas after the delay time has elapsed. Should a detector still be active at the end of the arming delay, (e.g. window opened), then arming does not take place. An elapsing arming delay can be cancelled at any time by unarming. The setting "0 s" deactivates the arming delay for the internal arming operation. When setting the time, a time reserve should be planned, so that the user is still able to leave the building area to be secured correctly before actual arming.
Alarm delay time, internal [s]	0...255	An alarm delay can optionally be configured for the internal alarm. An alarm delay is often used when the switching device (e.g. the panel or a button sensor) is installed in the secure area. In such cases, authorised people must be able to enter the secured building area, meaning the status the switching device for unarming can only be reached after a delay. This parameter sets the internal alarm delay time. The setting "0 s" deactivates the alarm delay for the internal arming operation.

<p>Prealarm, internal</p>	<p>No Via internal buzzer Via object Via object and internal buzzer</p>	<p>Optionally, if an internal alarm delay time is running during system operation, a "Prealarm" can be activated first. Depending on the parameter configuration, a prealarm is signalled here by the piezo buzzer of the panel and/or a separate 1 bit object. During a prealarm, an authorised person can unarm the system without triggering a 'real' alarm. The transition to the "Alarm" status only takes place if the system is not unarmed during the prealarm. This parameter only has an effect when an internal alarm delay time is configured to greater than "0 s".</p>
<p><input type="checkbox"/> Signalling system -> External arming</p>		
<p>Visual acknowledgement on external arming</p>	<p>Yes No</p>	<p>If the system has armed successfully, acknowledgement may take place via the visual signal encoder. This means that it is possible to detect clearly whether the system has responded to an arm command as required or not. This is primarily important when the system is operated remotely (without being to see the panel) or in the case of an arming delay. When set to "Yes", this parameter enables visual acknowledgement. The length of acknowledgement is defined by the "Arming acknowledgement time" parameter.</p>
<p>Arming delay, external [s]</p>	<p>0...255</p>	<p>The arming delay time, which can be set here, specifies after what time after an arming command ("1" telegram via the "Externally armed" object or pressing of the "Arm" button on the panel) the system is actually externally armed. In so doing the signalling system only checks the arming readiness of the security areas after the delay time has elapsed. Should a detector still be active at the end of the arming delay, (e.g. front door not closed or window opened), then arming does not take place. An elapsing arming delay can be cancelled at any time by unarming. The setting "0 s" deactivates the arming delay for the external arming operation. When setting the time, a time reserve should be planned, so that the user is still able to leave the building to be secured correctly before actual arming.</p>

Alarm delay time, external [s]	0...255	<p>An alarm delay can optionally be configured for internal and external alarm. An alarm delay is often used when the switching device (e.g. the panel or a button sensor) is installed in the secure area. In such cases, authorised people must be able to enter the secured building area, meaning the status the switching device for unarming can only be reached after a delay. This parameter sets the external alarm delay time. The setting "0 s" deactivates the alarm delay for the external arming operation.</p>
Prealarm, external	<p>No Via internal buzzer Via object Via object and internal buzzer</p>	<p>Optionally, if an external alarm delay time is running during system operation, a "Prealarm" can be activated first. Depending on the parameter configuration, a prealarm is signalled here by the piezo buzzer of the panel and/or a separate 1 bit object. During a prealarm, an authorised person can unarm the system without triggering a 'real' alarm. The transition to the "Alarm" status only takes place if the system is not unarmed during the prealarm. This parameter only has an effect when an external alarm delay time is configured to greater than "0 s".</p>
<p><input type="checkbox"/> Signalling system -> Security area ... -> [Detector text]</p>		
Detector text	[Detector]	<p>A detector can be assigned a detector text here, which then clearly identifies the detector. This text may be a maximum of 14 characters long (e.g. "Kitchen window", "Garage door") and later, during system operation, if there is activity on the part of the detector, an alarm or a fault, is either displayed in the detector list on the panel screen or in the event memory. Optionally, if there is an alarm, the detector text can be transmitted to the bus using separate 14 byte communication objects.</p>
Detector type	<p>Contact Movement Glass break</p>	<p>The detector type of a detector (contact, movement, glass break) is specified here. The configured type only specifies the text display in the detector list of the panel and has no further effect on the behaviour of a detector.</p>
Input active on	<p>0 telegram 1 telegram</p>	<p>This parameter can configure each detector input to different telegram</p>

polarities, i.e. the detector can be active with a "1" telegram or a "0" telegram. The polarities configured in the signalling system must agree the flank parameters of the bus subscribers to which the detectors are connected.

☐☐ Light scenes -> General

Password level	No password protection	If a password level is set here, then the user must enter the correct password to open the light scene overview page, if the previous page has a lower password level.
	Password level 1	
	Password level 2	
	Password level 3	
	Password level 4	

☐☐ Light scenes -> Extension

Extension object	Yes No	This parameter enables the extension object of the light scene function. This object can be used to open or save the internally saved light scenes during panel operation.

Saving by extension	Disabled Enabled	This parameter enables the save function of the light scene function. In the "Enabled" setting, new light scene values can be saved during panel operation by receiving save telegrams via the extension object. In the "Disabled" setting, it is not possible to save new values using the extension object.

☐☐ Light scenes -> Light scene collection -> [Light scene page heading]

Heading	[Light scenes - Page 1 of 3]	This parameter specifies the heading of the appropriate light scene. The heading appears as a name in the parameter node above the plug-in and also on the panel display. This parameter is available on each light scene page (1...3).

☐☐ Light scenes -> Light scene collection -> [Light scene page heading] -> [Light scene designation]

Designation	[Light scene]	This parameter specifies the designation of the appropriate light scene. The designation only appears as the parameter node name within the plug-in. This parameter is available for each light scene created.

☐☐ Light scenes -> Groups -> [Heading, light scenes group page]

Heading	[Light scene group - Page 1 of 4]	This parameter specifies the heading of the appropriate light scene group page. The heading appears as a name in the parameter node above the plug-in and also on the panel display. This parameter is available on each light scene group page (1...4).
<input type="checkbox"/> Light scenes -> Groups -> [Heading, light scenes group page] -> [Light scenes group designation]		
Designation	[Light scene group]	This parameter specifies the designation of the appropriate light scene group. The designation only appears as the parameter node name within the plug-in. This parameter is available for each light scene group created.
Object type, light scene group	DPT 1.001 (1 bit switching) DPT 5.001 ... 5.004 (1 byte relative value)	The datatype of the light scene group object can be set here.

4.3 PC Client software

4.3.1 Introduction, installation and program start

Installing the PC Client software

The PC Client software allows simultaneous operation of the panel from a PC (remote operation). All the display elements of the panel are displayed to the end user on the PC monitor and can be operated remotely by clicking the mouse - as if being done directly on the panel by touch. This allows the operation of display elements and function buttons, meaning that time switch, light scene and limit values settings can also be changed. In addition, all the status displays of the panel can be checked on the PC.

The end user can also use the PC Client software to load various configuration data (IP settings, e-mail mailboxes, RSS Newsfeeds, project planning, firmware) into the panel without requiring access to the ETS.

The PC Client software program is an EXE program which can be executed by the end user and which must be installed on the PC before first use. For this reason, the program is supplied as installation package. Executing the installation package opens the Setup program, which provides an easy guide through the installation process and installs the PC Client software correctly on the PC.

- i** The PC Client software can be run on PCs with the operating systems Windows XP, Windows 2000 or Windows Vista.

It is possible to load the device firmware and the project planning data into the panel by USB using the PC Client software. To allow USB device programming, a USB driver must be installed on the commissioning PC. To ensure correct installation of the USB driver, the panel must not be connected to the PC before installing the driver. The driver required for USB programming is supplied and installed together with the PC Client software.

- i** The appropriate access rights in the operating system are required for driver installation.
- i** Some PC operating systems test during installation whether the USB drivers have certificates. The appropriate messages can be ignored and installation continued.

After the PC Client software has been installed, a project file must be created before first operation. The exact procedure is described in the next section.

Creating a project

The PC Client software can be opened after a successful installation operation. Opening is possible - depending on the options selected during installation - either by double-clicking the program icon on the desktop or, alternatively, via the Start menu or the Quick Start bar of the operating system.

When the program is started, an empty project desktop is seen.

To use the PC Client software, a project must be opened. A project can be created in a word processing program like any document, if there is no existing project file, or can also be opened, if a project file has already been created and saved. In the PC Client software, a project file can be created or opened and saved in the "Project" menu.

A separate project file is required for each communication connection to a panel, as the file contains the project planning and the IP communication settings of the appropriate panel. For this reason, when assigning a name to the project file (file ending: "*.eipc"), a meaningful name should be selected to identify the device to be controlled (e.g. "Remote control, office panel.eipc"). The filename is assigned on saving.

Creating a new project file

If a panel is to be controlled with the PC Client software for the first time, a new project must be created. The "Project Creation Wizard" is launched using "Project -> New". The Wizard asks the user to specify a device name (e.g. "Office panel"), a more accurate device description (e.g. "Panel next to door into office") and the important IP communication parameters as a precondition for perfect communication between the software and the panel. The necessary settings of the IP addresses and ports must agree with the IP settings of the panel.

If, at the time a project is created, there should not be any valid IP parameters available or various parameters change, they can also be set or changed later as part of configuration (menu "Settings -> Device connection settings").

The Project Creation Wizard is exited when all the entries when made correctly and the "Complete" button is pressed. The PC Client software transfers the IP settings of the Wizard to the configuration and enables the "Remote operation" and "Settings" menus. After this, the PC Client software is ready for operation.

"Project -> Save as" allows the project to be saved after creation, archiving them for later access.

Opening an existing project

A project file is usually available when a panel has been connected and configured using the PC Client software and then a project file is created and saved. "Project -> Open file" can be used to open existing project data and read it into the PC Client software. Then the "Remote operation" and "Settings" menus are enabled. After this, the PC Client software is ready for operation.

If an existing project was opened and then the "New" menu item is opened, then all the settings of the current project are lost and replaced by the Project Creation Wizard. For this reason, it is wise to save and close opened projects before creating new projects.

- i** The following should always be observed with regard to communication between the PC Client software and the panel:
A panel can therefore be configured or operated by only one PC Client software at any one time, i.e. by just one PC. Simultaneous control with a second PC is not possible. However, control by different PCs at different times is possible.
However, the PC Client software can be launched several times on a PC, allowing simultaneous, independent control of multiple panels (different IP connections).

4.3.2 Connection settings, data exchange and device update

Device connection settings

For the PC Client software to be able to communicate with a panel via the Ethernet interface, it is necessary to specify the device connection settings. When a new project file is created, the communication parameters are usually defined in the Project Creation Wizard. When a project is completed, the PC Client software transfers the communication parameters to the device connection data. This data can be completed or modified at any time by opening the menu item "Settings -> Device connection settings". The "Set device connection data" window then appears in the software.

The device connection settings are specified in three stages in the "Device connection data" window. Each step is overwritten with its own tab. The "General", "IP" and "Datalogger" tabs can be opened...

- "General" tab
The device description of the panel is specified here. An identifying text of max. 15 characters can be entered under "Device name" (e.g. "Office panel"). This text is then applied to the device memory of the panel on loading the configuration settings, and also displayed in the heading of the PC Client software window to identify the current project. An additional text of any length can be entered under "Device description". This text (e.g. "Panel next to the door into the office") is only used as a more detailed description of the device name and is only displayed within the PC Client software.
The device name and device description are always applied automatically with the IP configuration settings of the panel (menu "Settings -> IP -> General").

- "IP" tab

The IP communication parameters for the Ethernet connection are defined here. It is important to make exactly the same settings here as are stored in the panel. The "IP address" and the "Ports" used must therefore agree with the values of the same name in the panel. The valid IP settings of the panel can be viewed on the device on the service page under "Area 3 <Administrator> -> IP settings" and applied in exactly the same way. When DHCP is used for automatic address allocation in the network, it should be noted that the DHCP Server always assigns different IP addresses to the panel on a initialisation operation after a device reset, which must then be applied to the connection settings. If, during system operation, device resets are common, e.g. due to power supply disconnections, then static IP addresses should be used.

The communication connection between the PC Client software and the panel is protected by a password to avoid unauthorised access to the device. With the PC Client software, the device password is set on the "IP" tab. The password entered in the PC Client software and the panel must be identical. The password for the panel is configured in the top parameter node of the "General" parameter group.

The device password may be a maximum of 16 characters in length. The box can also be left empty in the PC Client software and in the ETS plug-in, meaning that communication between the PC Client software and the panel takes place without password protection. The password is indicated in the input box by "*" and encrypted in the communication connection. This means that it is safe from sabotage.

- "Datalogger" tab

The PC Client software can also read out the recorded data values of the datalogger. This allows simple recording of, for example, counter values or other consumption data and archiving in a CSV file format. When the data is loaded from the device, the PC Client software saves the CSV files of each datalogger channel to a target folder. This save location can be edited on the "Datalogger" tab.

The CSV is clearly indicated in the filename. This makes the datalogger channel number and the date and time clear in the name. The date and time are derived from the data value of the last time interval of the appropriate datalogger channel. A prefix can be optionally added to the filename. In this way, the device name can, for example, be applied to the filename, allowing clear identification of the source of the datalogger data.

- i** If the PC Client software is unable to create a remote or configuration connection to the panel due to incorrect device connection settings, then an error message is displayed. In this case, the IP connection settings (IP address, ports) are compare with the valid values of the panel. This must especially be complied with in the case of DHCP-administered networks.

Data exchange, reading out the datalogger

The PC Client software can also read out the recorded data values of the datalogger. This allows simple recording of, for example, counter values or other consumption data and archiving in a CSV file format. When the data is loaded from the device, the PC Client software saves the CSV files of each datalogger channel to a target folder, defined in the device connection settings.

Reading out of the datalogger can be started in the "Settings" menu by opening the menu item "Load datalogger data from the device...". The PC Client software then sets up an IP connection to the panel, reads out the data values and saves them to a CSV file. The successfully read-out datalogger channels and the filenames and save locations are displayed to the end user in a separate message window. Then, the saved files can be opened and viewed and processed in a suitable table calculation.

- i** For the PC Client software to read out the datalogger, the device connection settings (IP address of the panel and the communication port) must be set correctly (see section "Device connection settings"). In addition, it is necessary to switch on the panel and connect it to the network.
During the read-out operation, the communication status is displayed in colour on the bottom edge of the PC Client software window.

Device update - firmware and project data download

Firmware download:

The panel has the option of loading new firmware into the device memory via the Ethernet interface or USB. This operation may, for example, be necessary if, during device development, new functions were created or are to be used. New functions or function adaptations are only available in the device when new firmware has been fully programmed in the device memory.

Firmware programming by USB is always possible in the ETS using the plug-in ("Settings -> Options -> Hardware -> Transfer all on ext download", then "Download -> Start download"). This operation can be carried out at any time, e.g. by the end user, via Ethernet or USB using the PC Client software without accessing the ETS.

A firmware file must be available for the PC Client software to load firmware into the panel. The installation engineer or project planner of the KNX/EIB system can use the ETS plug-in of the panel to save the firmware file and - if required - hand it over to the end user. The firmware can be saved in the plug-in using "Settings -> Options -> Hardware".

The end user then loads the file into the PC Client software under "Settings -> Firmware ..." and then executes a firmware download. The communication interface (IP or USB) can also be selected in this context.

To enable a USB connection to the panel, the USB driver, which is a component part of the installation of the PC Client software, must be installed.

During transmission via IP, the firmware is first fully loaded into the device. This process may take several minutes. During this time, the panel can still be operated. Only when the download is complete is the new firmware installed internally with a subsequent panel restart. With USB transmission, programming and installation take place at the same time. During this time, the panel cannot be operated.

There is no project data in a device after a firmware programming operation using the PC Client software. The panel is constantly in the initialisation status and displays the Start screen. The project data must then be loaded into the device.

Project data download:

Just as with the ETS, the PC Client software can be used to load project planning data into the device. For example, the project data must be loaded if new firmware was previously programmed into the panel using the PC Client software. Irrespective of this, a project data download using the PC Client software can also be useful if, for example, an end user receives a project file from the installation engineer or project planner, which the user can then program into the device themselves, without accessing the ETS.

A project file must be available for the PC Client software to load project planning data into the panel. The installation engineer or project planner of the KNX/EIB system can use the ETS plug-in of the panel to save the project file and - if required - hand it over to the end user. Selecting "Download -> Download to file" causes the ETS plug-in to generate a project file. The plug-in then compiles a project file with a new project ID and saves it in the specified directory. The name of the file saved in this manner contains the previously compiled project ID. The name can be changed, although the project ID within the file is not changed. The ID is important for a later remote connection or further programming operations, and permits the detection of valid project data. The file ending of the project file is defined as "*.mtc" and may not be changed.

The end user then loads the file into the PC Client software under "Settings -> Firmware ..." and then executes a project data download. The communication interface (IP or USB) can also be selected in this context. Depending on the scope, project data planning may take several minutes.

- i The project file is temporary and its contents correspond to the project created in the ETS plug-in, including all the image, object and parameter configurations. Even if the smallest changes are made to the device project planning (group addresses changed, parameters modified...), then it is also necessary to save a new project file, if the panel is to be commissioned using the PC Client software. Commissioning using the PC Client software, i.e. downloading project data, corresponds to a download executed by the ETS plug-in (menu "Download -> Start download").

4.3.3 Configuration data (IP, e-mail, RSS)

Configuration data

The panel can be configured using the PC Client software. This means that the settings for the e-mail mailboxes and RSS newsfeeds can only be edited in the PC Client software. This gives the end user the option of easy adjustment of the sources of their e-mails and RSS newsfeeds on the PC, without the need to access the ETS. In addition, in contrast to direct adjustment by touch operation, the IP communication parameters of the panel can also be configured in the PC Client software.

The configuration parameters are available in the "Settings" menu of the PC Client software as soon as a project has been created or opened.

There are two basic methods of setting the configuration data in the PC Client software. On the one hand it is possible to enter the IP parameters, the e-mail mailboxes and the RSS newsfeeds directly into the input screen of the PC Client software and then program them into the panel. This procedure is recommended for first project planning of a panel. In this case, any configuration data in the panel are completely overwritten.

Alternatively, the configuration data currently stored in the panel can be read out and then edited or added to, before the data is programmed back into the panel. This procedure is advisable when a panel with valid data has been commissioned and additions or corrections to the configuration data are required. In this case, the existing data can remain in the panel.

Loading configuration data out of the device

If the "Loading configuration data out of the device..." item is opened in the "Settings" menu, the PC Client software then automatically sets up an IP connection to the panel. The communication parameters defined in the device connection settings are used. During the connection, the software reads out all the configuration data of the panel (IP parameters, e-mail mailboxes, RSS newsfeeds) and transfers this data to the appropriate input screens. Then the data can be viewed and edited or added to (see next sections). The data is empty and partially preinitialised if a panel is read out, which does not yet possess any valid configuration data.

- i** For the PC Client software to read out the configuration data successfully, the device connection settings (IP address of the panel and the communication port) must be set correctly (see section "Device connection settings"). In addition, it is necessary to switch on the panel and connect it to the network. Should these preconditions not be complied with, it is not possible to read out the configuration data and the PC Client software cancels the operation with an error message.
During a read-out operation, the communication status is displayed in colour on the bottom edge of the PC Client software window.

IP parameters

Basic principles

The panel communicates with the PC Client software via the Ethernet interface per TCP/IP (Transport Control Protocol – Internet Protocol). For this communication protocol to work correctly, the IP settings of the panel must be correctly planned. IP settings can either be configured directly on the panel or using the PC Client software. This configuration can be carried out by opening the "IP" item in the "Settings" menu.

The following settings are possible...

IP address:

Each subscriber in a network (LAN, WAN) has their own unique IP address. This Internet address is a 32 bit value, always specified in the form of four decimal numbers separated by

dots (8 bit values) for easier comprehension. This method of display is called dot notation. Here is an example of a possible IP address of the panel: 192.168.1.2.
The panel also required a clear IP address for identification and communication in the local network.

Subnet mask:

The Internet address is subdivided into the Net ID and Host ID to distinguish between the individual networks. The Net ID addresses the network and the Host ID addresses the network subscribers (e.g. PC or panel). Telephone numbers are structured in a similar way. Here too, a distinction is made between the dialling code and the actual telephone number. The Net ID shows whether the recipient, to whom a network connection is to be setup, is in the same individual network as the sender or not. If this part of the IP address is the same for both the sender and the recipient, then both communication partners are located in the same network. If it does not match, then the recipient is located in a different network.

Which part of the IP address belonging to the Net ID and which to the Host ID depends on the size of the individual network (subnet) and is primarily determined by the subnet mask. Just like the IP address, the subnet mask is also a 32 bit value, shown in dot notation. The panel also requires a subnet mask in the IP configuration to detect the relationship to the network topology.

Standard gateway:

If the subnet mask is viewed in binary, then the section of the Net ID is filled with ones and the section of the Host ID with zeroes. With each data packet to be sent, the sender compare their own IP address with that of the recipient. In so doing, the bits of the Host ID beyond the part of the subnet mask filled with zeroes is hidden. If the evaluated bits of the two IP address are identical, then the network subscriber to be contacted is in the same subnet. If just one of the evaluated bits is different, then the selected network subscriber is not located in the same subnet. In this case, the data packet must be handed over to a standard gateway to be switched into the target network - for example, the Internet. In many cases, the standard gateway is - and this occurs extremely often in private networks - a DSL router, which connects the local network with the Internet.

The panel also requires the IP address of a standard gateway when communication beyond the borders of the local network is necessary.

DNS-Server:

There are millions of IP addresses on the Internet. Users would have difficulty handling the different addresses - even in smaller home networks - because the long numbers are either very difficult to remember or are completely unknown. This is where the DNS (Domain Name System) helps. Here, allocations of IP addresses and domain names are stored on DNS Servers, are constantly managed and polled as necessary. The DNS can be seen as the telephone directory of the Internet.

The panel also allows the user or the installation engineer as an administrator to enter domain names rather than direct IP addresses at some points (e.g. for e-mail Servers or RSS sources). For this reason, the panel, just like a web browser, also needs the valid address of a DNS Server, in order to poll the names there and then resolve the IP address. Therefore, a DNS Server must also be entered in the IP configuration of the panel.

- i Valid IP addresses for DNS Servers are available from the network administrator or the responsible Internet service provider (ISP). In some cases, mini DNS Servers are already integrated in the Internet route of the network. However, this depends on the router used. In such cases, the address of the DNS Server is the same as the address of the standard gateway.

DHCP:

As described above, to communicate with other network subscribers, the panel needs their IP address, its own subnet mask and, if necessary, the IP address of an available gateway and of a DNS Server. These addresses can always be specified during panel commissioning and entered in the device configuration. For this, the network administrator must hand over the information to the operator or the installation engineer.

In larger networks, this method soon causes a lot of configuration and management work. For this reason, amongst others, the use of DHCP (Dynamic Host Control Protocol) is advisable.

With DHCP, network settings of the individual terminals, such as the IP addresses required, can be agreed automatically and in a standardised manner, and configured centrally. To use DHCP, at least one DHCP Server is required in the network, in order to manage the configuration data for a specified IP address range. As a DHCP-compatible terminal, every time the power supply is switched on, the panel polls its own IP address from the DHCP Server along with the corresponding parameters such as subnet mask, standard gateway and DNS address, assuming that DHCP is activated.

Modern routers, used, for example, to connect a single network to the Internet, often in conjunction with DSL connection in private homes, usually have a integrated DHCP Server. This means that DHCP can also be used in smaller networks.

AutoIP for DHCP:

In some cases, the panel may load a network configuration through DHCP, a configuration for which at that point no DHCP Server can be contacted. In this case, the panel assigns itself an IP address from a predefined AutoIP range and initialises itself with the self-assigned address. In so doing, the panel checks to see if the address is not already used by another network subscriber.

IP ports:

IP ports are address components used in network protocols, in order to assign data packets to the correct services. The size of the port number is 16 bits, i.e. it can accept values between 0 and 65535. Certain applications used permanently assigned, generally known port numbers. Usually, these are between 0 and 1023, and are termed 'well known' ports (e.g. HTTP port 80, FTP port 21). The registered ports are between port 1024 and 49151. These can be registered as necessary by applications' manufacturers for their own protocols, like domain names. The remaining ports to port 65535 are so-called dynamic and/or private ports. These can be used variably, as they are not registered and thus do not belong to any application.

The panel also uses various ports for special IP connections to the panel which can primarily be set up using the PC Client software. For example, with remote operation, port "3261" is used. For configuration along the Ethernet cable (as described in this chapter), port "3262" is used, and port "3263" is used for Ethernet firmware or project data downloads.

The named port addresses are predefined in the factory settings of the panel. However, during IP configuration, they can be changed to any other values within the approved port value range, if the prespecified values are already used elsewhere in the network.

Settings

If the "IP" item is opened in the "Settings" menu, the "Device IP configuration" window opens. The IP parameters are spread across the following tabs...

- "General" tab
The device description of the panel is specified here. An identifying text of max. 15 characters can be entered under "Device name" (e.g. "Office panel"). This text is then applied to the device memory of the panel on loading the configuration settings, and also displayed in the heading of the PC Client software window to identify the current project. An additional text of any length can be entered under "Device description". This text (e.g. "Panel next to the door into the office") is only used as a more detailed description of the device name and is only displayed within the PC Client software.
The device name and device description are always applied automatically with the device connection settings of the panel (menu "Settings -> Device connection settings").

- "IP" tab
The IP communication parameters of the panel are defined here. The setting "Obtain IP address automatically" activates DHCP (corresponds to the factory setting). In this case, it is not necessary to configure additional IP addresses. The appropriate fields cannot then be edited.
Alternatively, the setting "Use following IP addresses" can be used. In this case, DHCP is deactivated on the panel, meaning that the IP address, subnet mask, the standard gateway and the DNS Server address must be entered in the fields.
The predefined port addresses can also be edited. However, this should only be done when the addresses entered in the network have already been used by other services.

Important: after configuration of the IP parameters, the configuration data can be written to the device (see section "Writing the configuration data to the device"). The panel then initialises and then works only with the new IP parameters. For the PC Client software to connect to the panel via the Ethernet interface, it is important to compare the device connection data with all the IP parameters. Otherwise the PC Client software will not be able to communication with the panel. This must especially be noted in the case of DHCP-administered networks.

- i** The communication connection between the PC Client software and the panel is protected by a password to avoid unauthorised access to the device. The password for the panel is configured in the top parameter node of the "General" parameter group.
- i** When DHCP is used for automatic address allocation in the network, it should be noted that the DHCP Server always assigns different IP addresses to the panel on a initialisation operation after a device reset, which must then be applied to the connection settings. If, during system operation, device resets are common, e.g. due to power supply disconnections, then static IP addresses should be used.
- i** For IP communication to be possible between the PC Client software and the panel via the Internet, the routers or proxy servers in between must be able forward the Internet telegrams in the local networks to the panel or the PC Client software. NAT (Network Address Translation) can be used for this. In so doing, the IP telegrams from the Internet are converted to the local IP addresses of the panel or the PC. The port addresses may also need conversion. It should also be ensured that the IP telegrams or ports are not blocked by firewalls. The network administrators can usually provide additional information on the settings required on the panel or in the PC Client software.
- i** In administrated networks, it may be necessary to know the MAC address of the panel (Media Access Control). This address is permanently programmed into the device memory when the device ins manufactured and thus cannot be edited. The MAC address can be viewed on the Service page of a panel under "Area 3 <Administrator> -> Version".
- i** The set IP parameters are a component part of the opened project of the PC Client software. The settings in the project file are permanently saved, if the menu item "Save" or "Save as" is select in the "Project" menu.

e-mail mailboxes

Basic principles

e-mail is a service in computer networks (primarily the Internet) allowing electronic messages to be exchanged between a sender and one or more recipients. Alongside the World Wide Web (www), e-mail is the most currently used service on the Internet. In contrast to many other applications on the Internet or in the LAN, sending e-mails is an operation in which there is no direct connection between the sender and receiver. To be independent of a permanent connection, the e-mail recipient requires a mailbox on a mail server in which incoming messages are stored. In the same way, the sender of an e-mail deposits the electronic post in the recipient's mailbox. For this, the sender also requires a valid e-mail mailbox.

There must be at least one valid e-mail mailbox configured for the panel to be able to receive and deposit e-mails. It is only possible to configure e-mail mailboxes in the PC Client software, allowing the end user to set their e-mail mailboxes themselves at any time, without the need to access the ETS. Configuration of the e-mail mailboxes can be carried out by opening the "e-mail" item in the "Settings" menu.

The following settings are possible...

POP3 or IMAP:

During reception of messages from mail servers, the panel supports the synchronisation using POP3 (Post Office Protocol of Generation 3) or alternatively via IMAPv4 (Internet Message Access Protocol of Version 4). These protocol variants can be configured independently in the PC Client software for the up to five mailboxes.

- i** The following information should be observed with regard to the configured inbox protocol (IMAPv4, POP3):
With IMAPv4, only the "Inbox" directory of the mail server is synchronised. The panel does not poll other directories. In addition, the panel cannot modify the directory structure on the IMAP mail server. With IMAP, the e-mails stay on the server. The panel only ever downloads a copy of the message.
With POP3 too, only copies of the messages are downloaded. The originals remain on the mail server until 'Delete' is pressed on the panel.
- i** The panel does not support encryption of the communication of the mail server (e.g. SSL).

SMTP:

SMTP (Simple Mail Transfer Protocol) controls the sending of an e-mail to the mail server of the recipient. When the e-mail has reached its destination, it is deposited in the recipient's mailbox and remains there until the recipient collects it. The panel also uses SMTP to send e-mail mailboxes.

For security reasons, some service providers required authentication of the sender at the beginning of communication when e-mails are sent via SMTP. Usually, it is necessary to open one's own inbox before the e-mail is sent. As this situation also requires the transmission of a username and a password, it allows user authentication. The panel therefore offers the option of logging onto the server before sending e-mails via POP. The necessity for authentication is usually signalled by the service provider of the e-mail services or can be enquired about there.

Ports:

Communication takes place via various port addresses, according to the configured inbox protocol. POP3 usually uses the port address "110", IMAPv4 uses "143" as standard. A port address is also of importance for the SMTP service. This is defined as "25" by default.

To allow port address to be adapted to the services in heavily administered networks, it is possible to enter the port addresses 'manually' in the configuration of the PC Client software, and thus change them.

Mailbox poll:

The panel cyclically polls all the inboxes using the set protocol and checks to see if new e-mail have arrived. The poll time (time between the cyclic synchronisation operations) can be configured in minutes for each mailbox in the e-mail settings of the PC Client software, allowing

demand-orientated updating of the displayed messages on the panel.

Settings

If the "e-mail" item is opened in the "Settings" menu, the "Device IP configuration" window opens. The e-mail settings are split into various areas in this window. Up to five different mailboxes can be set up to receive e-mails. Each mailbox has its own tab. One SMTP mailbox can be set up to send e-mail messages, and is completely independent of the inboxes. The parameters for this outbox are in the lower area of the window, independently of the tabs for the inboxes.

There is no difference between the configuration options of the up to five inboxes. The following settings must be made correctly for all the available mailboxes...

- Settings for inboxes (tabs)

If a mailbox is to be used, it must be activated using the "Mailbox active" setting. Only mailboxes activated in this way can be seen in the "Mailboxes" page of the panel.

"Inbox type" specifies the inbox protocol used (IMAPv4, POP3). Only one protocol can be used for a mailbox at any one time.

"Mailbox display name" defines the name of the button on the "Mailboxes" system page.

The display name later helps the panel user to identify their e-mail mailboxes. Clear names, ideally an e-mail address of this mailbox, should be entered here.

The URL of the e-mail inbox server provided by the service provider (e.g. "imap.server.de") should be entered under "Inbox server".

"Port" specifies the communication port used for the service. Usually "110" should be entered for POP3 and "143" for IMAPv4. The PC Client software automatically enters the correct port address in the entry box when the protocol is selected.

"Username" and "Password" define the required access authorisations to open e-mail messages. The service provider supplies the access data.

"Poll mailbox every X minutes" defines the poll time (time between the cyclic synchronisation operations) of the mailbox. When the configured time has elapsed, the panel tries to set up a connection to the inbox server and poll e-mail messages. The setting "0 minutes" completely deactivates the automatic synchronisation with the appropriate mailbox. Then only 'manual' synchronisation directly on the panel is possible by pressing and holding down the Mailbox button. When setting the time, it should be noted that different service providers specify minimum poll times for the inbox (time between two synchronisations). Therefore, the set time should not be shorter than the specification of the service provider.

- Settings for the outbox (lower area of the window)

The URL of the e-mail outbox server provided by the service provider (e.g. "smtp.server.de") should be entered under "Server name".

"Port" specifies the communication port used for the service. Usually "25" should be entered for SMTP.

"Username" and "Password" define the required access authorisations to send e-mail messages. The service provider supplies the access data.

"Sender address" specifies the e-mail address which will appear as the source address in the e-mail message to be sent. Usually, a valid address of the mailbox is entered here.

If the service provider requires authentication on the inbox server before sending an e-mail message, then the checkbox "Log on to server before sending" should be activated.

- i** The set e-mail parameters are a component part of the opened project of the PC Client software. The settings in the project file are permanently saved, if the menu item "Save" or "Save as" is selected in the "Project" menu.

RSS newsfeeds

Basic principles:

The panel offers the option of synchronising RSS 2.0 newsfeeds and displaying them on the device monitor. RSS (Really Simple Syndication) is a service on websites, which publishes current contents, often messages headlines or journals (weblogs) at regularly intervals, and makes them available in simple text or image format. The provision of data in the RSS format is termed an RSS feed.

Newsfeeds are usually divided up into various categories by content, which are often shown directly in the title of a feed (e.g. politics, business, lifestyle, etc.). Each newsfeed automatically gives the reader new message contents (feed items). Each feed item consists of a title and contents. The contents can also contain simple images in addition to the text.

It is only possible to configure the RSS newsfeeds accessible in the panel in the PC Client software. In this way, the panel operator can configure their newsfeed sources independently of the ETS.

At least one valid newsfeed source must be specified in the PC Client software, in order to be able to display newsfeed contents. The panel can make a distinction between up to eight newsfeed sources.

Configuration of the RSS newsfeeds can be carried out by opening the "RSS Feeds" item in the "Settings" menu.

The following settings are possible for each RSS newsfeed...

Feed source (URL):

Each newsfeed must be compared with a source, i.e. a suitable server. The World Wide Web (www) contains countless offers for regular news or report publication. Many providers of these websites make RSS feeds available with the latest reports. Newsfeeds are usually linked directly to the website of a provider and can be localised and displayed using a web browser. The web address of an RSS feed (URL) looks very similar to that of a 'normal' website. The address of the feed (e.g. "http://www.feedexample.com") must be entered unchanged in the entry box of the PC Client software.

The Internet contains many RSS directory services, which considerably simplify the finding of available RSS newsfeeds and thus the URL required.

Update time:

The panel compares all the RSS sources cyclically and updates the message contents. The update time (time between the cyclic synchronisation operations) can be configured for each RSS source in hours in the PC Client software, allowing demand-orientated updating of the displayed messages on the panel.

- i** The synchronisation operation always runs in the background. During this time, the panel can be operated normally. Fault-free KNX/EIB communication is also guaranteed. It should be noted that the synchronisation operation may take several seconds, in the case of large contents even several minutes. For this reason, one should wait after each synchronisation until the feed contents can be fully displayed on the panel.

Settings

If the "RSS Feeds" item is opened in the "Settings" menu, the "Enter RSS Feed" window opens. The RSS sources can be defined here by entering the addresses (URL) in the entry boxes.

However, a newsfeed is only active and appears on the "Overview of RSS feeds" page on the panel when the "Feed active" checkbox has been selected.

In addition, the update time of the individual feeds must be entered. Update times of 1 ... 24 hours can be configured.

- i** The URL of a RSS newsfeed may be a maximum of 254 characters long. Special characters (e.g. Å Ä Ö ö Ü ü ß) are not permitted in the URL. Only HTTP feed addresses are accepted and not HTTPS (secure HTTP)!

- i** The set RSS newsfeed parameters are a component part of the opened project of the PC Client software. The settings in the project file are permanently saved, if the menu item "Save" or "Save as" is select in the "Project" menu.

Write configuration data to device

If the "Write configuration data to device..." item is opened in the "Settings" menu, the PC Client software then automatically sets up an IP connection to the panel. All the IP parameters, the e-mail mailboxes settings and the RSS newsfeed data are then programmed into the device. The configuration data in the panel up to this moment is overwritten.

- i** The configuration data are saved to the non-volatile memory of the device and then are available unchanged after a device reset.
- i** For the PC Client software to program the configuration data successfully, the device connection settings (IP address of the panel and the communication port) must be set correctly in the PC Client software (see section "Device connection settings"). In addition, it is necessary to switch on the panel and connect it to the network. Should these preconditions not be complied with, it is not possible to program the configuration data and the PC Client software cancels the operation with an error message.
During a programming operation, the communication status is displayed in colour on the bottom edge of the PC Client software window.
- i** After a programming operation, the panel initialises and then works only with the new IP parameters. For the PC Client software to reconnect to the panel via the Ethernet interface, it is important to compare the device connection data with all the IP parameters. Otherwise the PC Client software will not be able to communication with the panel. This must especially be noted in the case of DHCP-administered networks.
- i** If the configuration data of a panel currently in operation needs to be modified or tested, then the following menu sequence should be generally kept to...
 1. Load configuration data out of the device,
 2. Check or make IP settings,
 3. Check or make e-mail settings,
 4. Check or make RSS feed settings,
 5. Write configuration data to the device.
- i** The set configuration parameters are a component part of the opened project of the PC Client software. All the settings in the project file are permanently saved, if the menu item "Save" or "Save as" is select in the "Project" menu.

4.3.4 Remote operation

Introduction

The PC Client software allows simultaneous operation of the panel from a PC. This is termed remote operation. All the display elements of the panel are displayed to the end user on the PC monitor and can be operated remotely by clicking the mouse - as if being done directly on the panel by touch. This allows the operation of display elements and function buttons, meaning that time switch, light scene and limit values settings can also be changed. In addition, all the status displays of the panel can be checked on the PC.

The "Remote Operation" menu is enabled as soon as a project is created or opened in the PC Client software. A tool-device comparison must take place before remote operation can be carried out.

Comparing tool-device data

To allow remote panel operation with all the project-specific user pages and image information, the PC Client software requires information on the project, which was most recently loaded into the panel. Before remote operation is even possible, there must be a data exchange between the PC Client software and the ETS plug-in or the panel, thus allowing a project data comparison. During the project data comparison, all the required tool device data is loaded into the PC Client software, also comparing the project ID. Remote operation is only possible when this loading operation has been completed successfully.

A tool-device comparison can take place in two ways. The data exchange either takes place using a device file, or the data is read out of the appropriate panel via an IP connection.

Data exchange using a device file:

A device file must be available for the tool device data to be loaded into the PC Client software. The installation engineer or project planner of the KNX/EIB system can use the ETS plug-in of the panel to save the device file and - if required - hand it over to the end user. The plug-in generates a device file when "Download -> Export device file for PC Client software..." is selected. The plug-in then generates a device file and saves it in the specified directory. The name of the file saved in this manner contains the project ID compiled during the last download. The name can be changed, although the project ID within the file is not changed. The project ID allows the detection of valid project data when remote operation is started. The file ending of the project file is defined as "*.mtc" and may not be changed.

Der Endanwender läd im Anschluss in der PC-Client Software unter "Remotebedienung -> Tool-Gerätedaten aus Datei laden..." die Datei ein.

Data exchange via IP connection:

The tool device data can be loaded directly into the PC Client software via an IP connection. For this, the menu item "Load tool device data from device" in the "Remote operation" menu of the software has to be selected. The PC Client software then automatically sets up an IP connection to the panel. In so doing, the device connection settings are used, which were configured in the menu item of the same name under "Settings".

The software loads all the tool device data and then exits the loading operation automatically. Depending on the scope of the project planning data, the load operation may take some time. During the operation, the communication status is displayed in colour on the bottom edge of the PC Client software window. The "Cancel" button will terminate the load operation before completion. In this case, the last data successfully read in remain valid.

Remote operation can be started when all the tool device data has been successfully read or loaded into the PC Client.

- i** The panel can only be operated remotely when the tool device data most recently loaded into the PC Client software have retained their validity. Should the project planning data in the panel have changed (for example after a new download), then a new tool-device comparison must take place with the PC Client software. Otherwise, remote operation will be impossible on account of the uncomparing and thus unmatching project ID. In this case, an error message is displayed in the PC Client software.
- i** The read or loaded in tool device data is a component part of the opened project of the PC Client software. The data in the project file is permanently saved, if the menu item "Save" or "Save as" is selected in the "Project" menu.

Executing remote operation

Remote operation can be started when all valid tool device data has been successfully read or loaded into the PC Client. It can be started using "Remote operation -> Start remote operation". The PC Client software then immediately sets up a continuous IP connection to the panel. In so doing, the device connection settings are used, which were configured in the menu item of the same name under "Settings".

After a successful connection operation, the display area of the PC Client software will show the content currently visible on the panel. Then the visible display elements, function buttons or the scroll bar can be operated as normal using mouse. Mouse clicks also represent short or long actuation, allowing, for example, time-controlled dimming or blind button functions to be executed as normal.

When the current screen contents are displayed in the PC Client software, the currently set colour scheme is taken into account. All the image elements (wallpapers, icon display or status elements) are displayed exactly as they are displayed on the panel.

The size of the display area in the PC Client software, i.e. also the size of all the screen contents, can be adjusted by a 3x zoom factor. Full screen display is also possible, meaning that the zoom factor currently set is maintained while the menu bars are hidden. This means that only the display area remains visible. This view is useful when the window of the PC Client software needs to remain in the foreground for a longer period of time. Full screen view can be terminated at any time by pressing the "F11" key on the PC keyboard.

A remote operation can be stopped using "Remote operation -> Stop remote operation". The PC Client software will then terminate the IP connection to the panel immediately and empty the display area.

- i** Due to IP communication, there may be a brief delay between the actuation of a display element or a function button and the appropriate reaction. In addition, the screen setup in the PC Client software may be slightly delayed when the view is changed.
- i** If, during an active remote connection, no IP communication to the panel is possible on account of a fault, the PC Client software will signal an error after a short time and will terminate remote operation.
- i** The touch surface of the panel cannot be calibrated remotely.

5 Appendix

5.1 Index

A		DNS	76-77
Acknowledgement of a fault message..	81, 124	E	
Acoustic signal.....	39	e-mail.....	127
Activating and deactivating an alarm...	122	e-mail mailboxes.....	215
Adding light scene groups.....	84	ETS	49
Adding light scenes.....	83	ETS search paths.....	15
Administrator settings.....	70	event memory.....	125
Alarm acknowledgement / "Unarmed ..	123	Executing remote operation.....	220
after alarm"		F	
Alarm delay / Prealarm.....	122	Fault messages.....	79
Arming/unarming the security areas....	119	G	
Astro function.....	92	General information on displaying the..	138
AutoIP.....	77	text contents of RSS newsfeeds	
B		General information on e-mail text ..	131
Basic principles.....	76	display	
Bus communication.....	40	group addresses.....	139
C		I	
Cause of fault and fault behaviour.....	124	images.....	47
colour schemes.....	38, 46	Install the USB drivers.....	10
commissioning.....	45	Installation position.....	37
Commissioning.....	10	Installing the PC Client software.....	205
Comparing tool-device data.....	219	Introduction.....	54, 83, 99, 105, 110
Configuration data.....	211	IP address.....	76-77
Connecting and mounting the device....	8	IP parameters.....	211
Creating a project.....	205	L	
Creating detectors and detector ..	115	light scenes.....	85
communication		Limit value monitoring.....	55-56
D		Loading configuration data out of the ..	211
Data exchange, reading out the ..	208	device	
datalogger		logical link.....	95
datalogger.....	99	M	
datalogger channel.....	103	Message list.....	82
Default setting.....	70	Message window.....	79
Detector list.....	116	Monitor display.....	38
Detector monitoring.....	117	multiplexer.....	97
Detector types.....	115	N	
Device connection settings.....	207	Number.....	19
device reset.....	126	O	
Device update - firmware and project ..	209	Object for display elements and/or ..	21
data download		function buttons and for the timer	
DHCP.....	77	switch (only partially)	
display element.....	55	Object for e-mail mailboxes.....	32
Display settings.....	68	Object for light scene function.....	36
display texts.....	39		
Displaying e-mail messages.....	128		
Displaying RSS newsfeeds.....	135		

Objects for datalogger.....	30	W	
Objects for general functions.....	19	Write configuration data to device.....	218
Objects for logic gate.....	28		
Objects for multiplexers.....	28		
Objects for presence simulation.....	31		
Objects for signalling system.....	32		
Objects for status elements in the status line ..	26		
Objects for the fault message function..	26		
Objects for the timers.....	27		
operating function.....	60		
Operation.....	12		
P			
Page areas.....	50		
Password for PC Client software.....	40		
passwords.....	75		
Prealarm.....	122		
preview window.....	49		
Programming the physical address.....	10		
R			
Random function.....	93		
real time clock.....	43		
Recording a telegram sequence.....	106		
RSS newsfeeds.....	217		
S			
scaling.....	47-48		
Scope of functions.....	16		
screen page.....	52		
Security areas and configuration.....	110		
Select functions.....	105		
Sending e-mail messages.....	132		
Sending the data values of the datalogger by e-mail message ..	133		
Service page.....	67		
Signalling during arming/unarming.....	120		
Single click operation.....	61		
Start page.....	39		
status line.....	64		
subnet mask.....	76-77		
Subsequent alarm.....	123		
switching times.....	89		
Synchronising mailboxes.....	128		
Synchronising RSS newsfeeds.....	135		
System settings.....	68		
System statuses.....	112		
T			
telegram sequence.....	108		
Timer switch.....	87		
timer switch channels.....	87		
timers.....	94		
Two click operation.....	61		

ALBRECHT JUNG GMBH & CO. KG
Volmestraße 1
D-58579 Schalksmühle

Telefon: +49.23 55.8 06-0
Telefax: +49.23 55.8 06-1 89
E-mail: mail.info@jung.de
Internet: www.jung.de
www.jung-katalog.de