

1:1



Flächenprogramm

Material

Duroplast/Thermoplast

Glas: Einscheibensicherheitsglas ESG, je nach Ausführung Rückseite bedruckt oder durchgefärbt

Kompatibel mit allen Abdeckungen aus der Serie A

Eine Kennzeichnung der JUNG Produkte mittels Laser oder Farbdruck erfolgt mit dem Graphic-Tool. Das Verfahren ist abhängig von Material und Farbe der Abdeckung. Mehr unter www.jung.de/gt.

Kunststoff

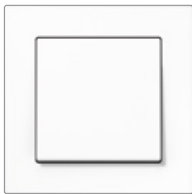

alpinweiß
ähnlich RAL 9010

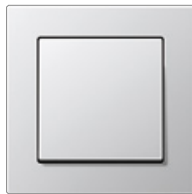

aluminium
lackiert



schwarz
ähnlich RAL 9005



champagner
lackiert



mokka lackiert

Glas



anthrazit



schwarz



rot



alpinweiß



blaugrau



mattweiß



silber (verspiegelt)



champagner



mokka

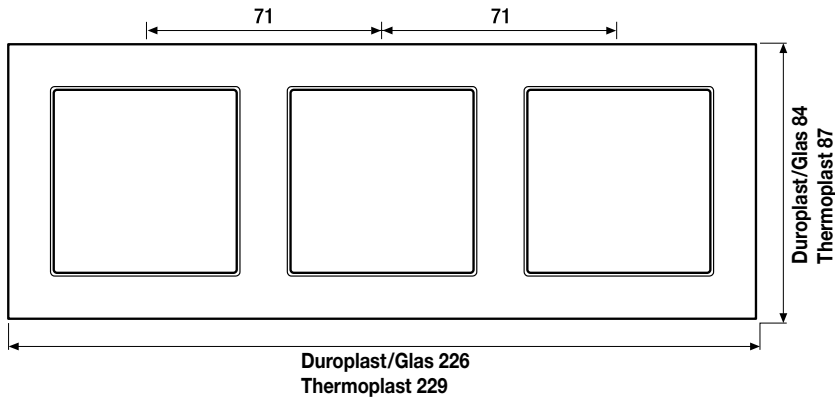
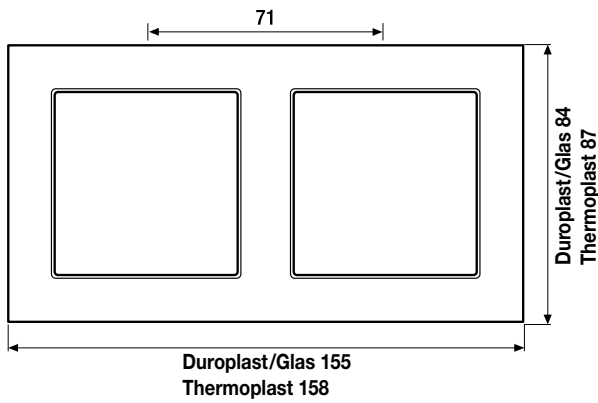
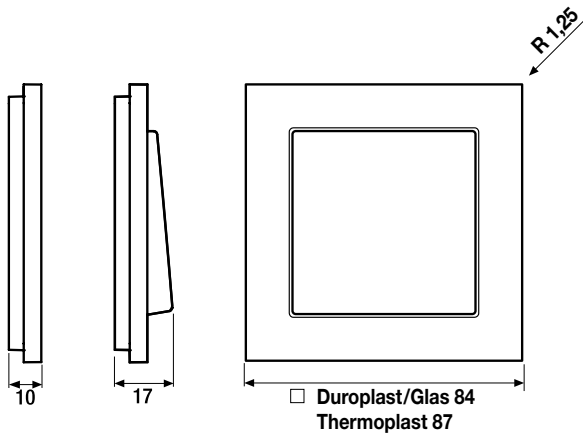
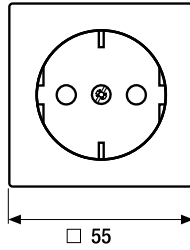
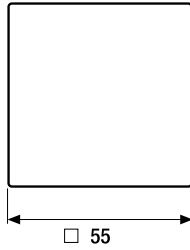

Rahmenmaße

Duroplast/Glas

- 1fach 84 mm x 84 mm
- 2fach 155 mm x 84 mm
- 3fach 226 mm x 84 mm
- 4fach 297 mm x 84 mm
- 5fach 368 mm x 84 mm

Thermoplast

- 1fach 87 mm x 87 mm
- 2fach 158 mm x 87 mm
- 3fach 229 mm x 87 mm
- 4fach 300 mm x 87 mm
- 5fach 371 mm x 87 mm

Die Rahmen sind waagrecht und senkrecht zu installieren.

Eckradius Rahmen R 1,25